

MPS4264

MINIATURE PRESSURE SCANNER

HARDWARE AND SOFTWARE MANUAL

SOFTWARE VERSION 3.05



Scanivalve

PREFACE

WARNINGS, CAUTIONS AND NOTES



WARNING

The WARNING! symbol indicates that danger of injury for persons and the environment and/or considerable damage (mortal danger, danger of injury) will occur if the respective safety precautions are not taken.



CAUTION

The CAUTION ! symbol indicates danger for the system and material if the respective safety precautions are not taken.



The ESD note symbol indicates that proper precautions for handling Electrostatic Sensitive Devices needs to be taken when performing the related operation. This includes the use of grounded work surfaces and personal wrist straps to prevent damage to sensitive electronic components.

WARRANTY

Scanivalve Corporation, Liberty Lake, Washington, hereafter referred to as Seller, warrants to the Buyer and the first end user that its products will be free from defects in workmanship and material for a period of twelve (12) months from date of delivery. Written notice of any claimed defect must be received by Seller within thirty (30) days after such defect is first discovered. The claimed defective product must be returned by prepaid transportation to Seller within ninety (90) days after the defect is first discovered. Seller's obligations under this Warranty are limited to repairing or replacing, at its option, any product or component part thereof that is proven to be other than as herein warranted.

Surface transportation charges covering any repaired or replacement product or component part shall be at Seller's expense; however, inspection, testing and return transportation charges covering any product or component part returned and redelivered, which proves

not to be defective, shall be at the expense of Buyer or the end user, whichever has returned such product or component part.

This Warranty does not extend to any Seller product or component part thereof which has been subjected to misuse, accident or improper installation, maintenance or application; or to any product or component part thereof which has been repaired or altered outside of Seller's facilities unless authorized in writing by Seller, or unless such installation, repair or alteration is performed by Seller; or to any labor charges whatsoever, whether for removal and/or reinstallation of the defective product or component part or otherwise, except for Seller's labor charges for repair or replacement in accordance with the Warranty. Any repaired or replacement product or component part thereof provided by Seller under this Warranty shall, upon redelivery to Buyer, be warranted for the unexpired portion of the original product warranty.

THIS WARRANTY IS IN LIEU OF AND EXCLUDES ALL OTHER WARRANTIES, EXPRESS OR IMPLIED, ARISING BY

OPERATION OF LAW OR OTHERWISE, INCLUDING THE IMPLIED WARRANTIES OF MERCHANTABILITY AND FITNESS FOR A PARTICULAR PURPOSE, AND IN NO EVENT SHALL SELLER BE LIABLE FOR INCIDENTAL OR CONSEQUENTIAL DAMAGES.

In the event of a failure:

1) Notify Scanivalve Corporation, Customer Service Department. Include model number and serial number. On receipt of this information, service data or shipping instructions will be forwarded. This may be transacted by telephone or e-mail.

2) On receipt of shipping instructions, forward the product, transportation prepaid. Repairs will be made and the product returned.

3) All shipments should be made via "Best Way". The product should be shipped in the original packing container or wrapped in protective material and surrounded by a minimum of four (4) inches of a shock absorbing material.

TRADEMARKS ® AND COPYRIGHTS ©

Scanivalve is a registered trademark of Scanivalve Corporation.

All other brand and product names are trademarks or registered trademarks of their respective companies.

PACKAGING FOR SHIPMENT

If the product must be shipped, whether being returned to Scanivalve or relocated to another location it must be packaged properly to minimize the risk of damage. The recommended method of packing is to place the instrument in a container, surrounded on all sides with at least four inches of shock attenuating material such as Styrofoam peanuts.

IMPORTANT NOTICE

Please note that the product specifications and other information contained in this manual are subject to change without notice. Scanivalve Corporation makes an effort and strives to provide complete and current information for the proper use of the equipment. If there are any questions regarding this manual or the proper use of the equipment, contact Scanivalve Corporation.

CONTACT INFORMATION

If there are any questions or concerns regarding any Scanivalve product please do not hesitate to contact us at the following:

Scanivalve Corp.
1722 N. Madson Street
Liberty Lake, WA 99019
Telephone: (800)935-5151 (509)891-9970
Fax: (509)891-9481
scanco@scanivalve.com
www.scanivalve.com

Scanivalve Corporation is an ISO 9001:2015 certified company.

[INTENTIONALLY LEFT BLANK]

TABLE OF CONTENTS

PREFACE	IV
Warnings, Cautions and Notes	iv
Warranty	iv
Trademarks ® and Copyrights ©	v
Packaging for Shipment	v
Important Notice	v
Contact Information	v
SECTION 1: SPECIFICATIONS	7
General Specifications	7
Environment Specifications	7
SECTION 2: INTRODUCTION	10
Overview	10
Module Configurations	10
Pressure Range	10
Valve Actuation	10
Pressure Sensors	10
Pneumatic Valve	11
Electronics - Pneumatic Valve	11
Electronics - Electric Valve	12
Pneumatic Inputs	12
Power & Ethernet Connections	13
SECTION 3: OPERATION	15
Unpack & Inventory	15
Mounting	15
Environmental Considerations	15
Warm-up	16
Communications	16
Serial Communications	16
Ethernet Communications	16
PC - TCP/IP	17
PC - UDP	17
PC - ScanTel	17
PC - LabVIEW	17
PC - HyperTerminal	17
FTP	17
Setting Up an Ethernet Connection	18
Using a Static IP address	18
Changing the IP Address	18
Using a Dynamic IP address	19
Web Server: Connecting	19
Web Server: Configuring Scan Settings & Scanning Data to a File	20

Web Server: Scanning Data to the Screen	21
Zero Cal	21
Web Server: “Remote” Screen	21
Web Server: “Terminal” Screen	22
Web Server: Electric Valve Options	22
FTP Scan Data Transfer	23
The Binary TCP Server	23
Commands	23
Scan Data	23
LabVIEW Scan Data	23
Example LabVIEW	23
Binary Data Buffering	23
Multiple Unit Operations	24
Multiple Unit Scan Command	24
Multiple Unit Stop Command	24
Multiple Unit Find Command	24
Scanning with an External Trigger	25
Setting up an External Frame Trigger	25
Setting up an External Scan Trigger	25
Auto Scan Option	25
Fast Scan Option (850Hz - 2500Hz)	25
SECTION 4: HARDWARE	28
Pneumatic Connections	28
Basics of Connecting Input Tubes	28
Pressure Measurement (Px) Ports	29
Calibration (CAL) Port	29
Reference (REF) Port	29
Purge (PRG) Ports	29
Calibrate Mode Control (CAL-PRG CTL) Port	29
Measurement Mode Control (Px CTL) Port	29
Removable Pressure Input Headers	30
Calibration Valve	30
Electrical Connectors	31
Ethernet Connector	31
MPSTCU - Thermal Control Unit	31
MPS4264TCU Overview Drawing	32
MPS4264TCU/EPx Overview Drawing	33
SECTION 5: SOFTWARE	35
Overview	35
Command Format	35
Output Scan Data Formatting and Routing	35
ASCII Data Formats	37
Basic ASCII Data Output	37
Formatted ASCII Data Output	38
ASCII CSV Data Output	38
Binary Data Formats	39
Binary Data Format	39

Fast Scan Binary Data Format	40
File Names and Formats	40
General Control Commands	41
Version	41
Boot Loader Version	41
Calibration Version	41
Firmware Files Check	41
Reboot	42
Status	42
Stop	42
TAR File Unpack	43
Valve State	43
Software Frame Trigger	43
Read Current Temperature	44
Identification Variables	45
List Identification Settings (LIST ID)	45
Set Serial Number (SN)	45
Set Nominal Pressure Range (NPR)	45
Set the Multiple Device Multicast Address (MCAST)	45
Save Commands	46
Save	46
Scan Variables	47
List Scan Settings (LIST S)	47
Set Rate (RATE)	47
Set Frames Per Scan (FPS)	48
Set Scan Units (UNITS)	48
Set Scanning Data Format (FORMAT)	49
Set Trigger (TRIG)	49
Set Enable FTP (ENFTP)	50
FTP Variables (LIST FTP)	51
LIST FTP Settings (LIST FTP)	51
Set User Name (USERFTP)	51
Set FTP Password (PASSFTP)	51
Set FTP IP Address (IPFTP)	52
Set FTP File Name (FILEFTP)	52
UDP Variables	53
List UDP Settings (LIST UDP)	53
Set UDP Enable (ENUUDP)	53
Set the UDP Target Address and Port (IPUDP)	53
Calibration and Validation Commands	54
Calibration	54
Calibration & Validation	54
Validation	55
Quick-Zero Offset Calibration (CALZ)	55
Calibration Variables (LIST C)	57
List Calibration Settings (LIST C)	57
Set Number of Points in Conversion Table (NUMPTS)	57
Set Minimum Calibration and Validation Values (MIN)	58
Set Maximum Calibration and Validation Values (MAX)	58
Set Oven and Calibrator Delays (DELAY)	58
Set the Calibrator IP Address, Port and Calibrator Number (IPCAL)	59
Set the Calibration and Validation Average (CALAVG)	59

Set Enable CALZ Before validation (VALZO)	59
Set Field Calibration Points (FCAL)	59
Set Field Validation Points (FVAL)	60
Oven Variables (LIST O)	61
List Oven Settings (LIST O)	61
Set the Oven IP Address, Port and Calibrator Number (IPOven)	61
Set the Oven Start Command (STARTOVEN)	61
Set the Oven Stop Command (STOPOVEN)	62
Set the Temperature Command (TEMPOVEN)	62
Conversion Table Variables	63
List Least-Squared Coefficients (LIST T)	63
Set Coefficients	63
Field Calibration Variables	64
List Field Calibration Settings (LIST FC)	64
Set Field Calibration Correction Status	64
Set Field Calibration Coefficients	64
Multicast Commands	65
Multiple Unit Find	65
Multiple Unit Stop	65
Multiple Unit Scan	65
IP Variables	66
List IP Settings (LIST IP)	66
Set IP Address of the MPS (IPADD)	66
Set Subnet of the MPS (SUBNET)	66
Set Login Name (LOGIN)	67
Set Password for Login Name (PASSWORD)	67
Set Login Name 1 (LOGIN1)	67
Set Password for Login Name 1 (PASSWORD1)	67
Set Allow Anonymous FTP Login (ALLOWANON)	67
Set Application File Name (APP)	68
Set Gateway (GW)	68
Set DNS Name (NAME)	68
Miscellaneous Variables	69
List Miscellaneous Settings (LIST M)	69
Set Simulation (SIM)	69
Set Echo (ECHO)	69
Set Excitation (XITE)	69
Set Server Select (SVRSEL)	70
Set Time Out (TO)	70
Set Delay Request (DREQ)	70
Set Validation Error Tolerance (ETOL)	71
Precision Time Protocol Variables (LIST PTP)	72
LIST Precision Time Protocol Settings (LIST PTP)	72
Set PTP Enable (PTPEN)	72
Set PTP Statistical Output (STAT)	72
Set Scan Start Time (SST)	73
Set Scan Start Date (SSD)	73
Set UTC Offset (UTCOFFSET)	73
Clear Accumulated PTP Statistical Data	74
Display PTP Statistics	74
Get PTP Time	74
Get Scan Start Time	74
Get UTC Offset	75

Set PTP Time	75
Electric Valve Commands	76
Valve State - Measurement Mode (EPX)	76
Valve State - Calibrate Mode (ECAL)	76
Valve State - Purge Mode (EPRG)	76
Electric Zero-Offset Calibration (ECALZ)	76
SECTION 6: MAINTENANCE	78
Firmware Installation & Configuration File Upload (Windows XP, 7, 10)	78
Calibration Coefficient Installation (Windows XP, 7, 10)	79
DIP Switches & Bootloader Mode	79
DIP Switches	79
When to operate in bootloader mode	79
How to operate in bootloader mode	79
Formatting the Flash Disk	80
Calibration & Validation Overview	82
Full Calibration & validation	82
Field Calibration & validation	82
Field Calibration & Validation Procedure	82
Setup and Configuration	82
Performing a Single or Multi-Field Calibration	83
Performing a Single or Multi-Field Validation	83
Performing a Single or Multi-Field Calibration-Validation	84
Manual Field Calibration-Validation Steps	85
Table 6-1: Recommended Cal/Val Settings	85
APPENDIX	86
Appendix A - Intra-Frame A/D Timing	86
Appendix B - Internal Socket Allocation	87
Appendix C - LabVIEW Client Example	88
Appendix D - 1588 Synchronized Scan Start	89
Appendix E - Engineering Unit Conversion Constants	91
Appendix F - Cable Drawings and Pinouts	92
MPS Premium Power/Serial/Trigger Cable	92
MPS Power/Trigger Cable with Flying Leads	92
MPS Premium Ethernet Cable	93
MPS to Female RJ45	93
MPSTCU Breakout Cable	94
Appendix G - Software Revision Log	95

[INTENTIONALLY LEFT BLANK]

SECTION 1: SPECIFICATIONS

GENERAL SPECIFICATIONS

Size (WxHxD) (includes tubes)

MPS4264	1.145" x 1.883" x 3.515" [29.08mm x 47.83mm x 89.28mm]
MPSTCU	4.295" x 2.350" x 6.882" [109.1mm x 59.69mm x 174.8mm]
MPSTCU - Cooling	4.295" x 2.350" x 7.522" [109.1mm x 59.69mm x 191.1mm]
MPS4264/EPx	1.145" x 1.883" x 6.600" [29.08mm x 47.83mm x 167.64mm]
MPSTCU/EPx	4.295" x 2.350" x 10.407" [109.1mm x 59.69mm x 264.35mm]
MPSTCU/EPx - Cooling	4.295" x 2.350" x 11.222" [109.1mm x 59.69mm x 285.05mm]

Weight

MPS4264/64CPx	7.65 oz [217g]
MPS4264/64NPx	7.8 oz [221g]
MPSTCU	31.52 oz [0.89kg]
MPS4264/64EPx	12.86 oz [365g]
MPSTCU/EPx	46.88 oz [1.32kg]

Inputs (Px)	MPS4264 0.042" [1.067mm] OD (standard)
	0.031" [.787mm] OD (optional)
	MPSTCU 0.063" [1.600mm]OD (standard)

Inputs (Cal, Ref, CTL, PRG)	0.063" [1.600mm] OD
--------------------------------	---------------------

Full Scale Ranges	±4 inH ₂ O, ±8 inH ₂ O, 1psid, 5psid, 15psid, 50psid [995.4Pa, 1990.7Pa, 6.89kPa, 34.5kPa, 103.4kPa, 344.7kPa]
-------------------	---

Accuracy

4 inH ₂ O	±0.20% FS
8 inH ₂ O	±0.15% FS
1psid	±0.06% FS
5psid	±0.06% FS
15psid	±0.06% FS
50psid	±0.06% FS

Overpressure (No damage)

4 inH ₂ O	4psid
8 inH ₂ O	4psid
1psid	10psid
5psid	40psid
15psid	75psid
50psid	100psid

Maximum

Reference Pressure	50psig (345kPa)
--------------------	-----------------

Data Output Rate (samples/channel/second)	850Hz (Binary) 2500Hz (Fast Mode) 15Hz (ASCII)
--	--

A/D Resolution	24bit
----------------	-------

Ethernet Connection	100baseT, MDIX auto-crossing
---------------------	------------------------------

Power Requirements

MPS4264	9-36Vdc, 3.5W
MPS4264TCU with Heater	20-30Vdc, 45W
MPS4264/EPx	18-36Vdc, 5.5W
MPSTCU/EPx with Heater	20-30Vdc, 45W

External Trigger	5-15Vdc, 6.5mA
------------------	----------------

Mating Connectors

Ethernet	TE Connectivity PLG 8P8C Mini2
Power	TE Connectivity PLG 8P8C Mini1
MPSTCU	17 Pin M12 Series

Control Pressure
Requirements

MPS4264/64CPx	65psi minimum
MPS4264/64NPx	90psi minimum
MPS4264/64EPx	N/A

ENVIRONMENT SPECIFICATIONS

Temperature

Operation	0 to 70 °C -60°C to 60°C with TCU heater -60°C to 125°C with TCU cooling
Storage	0 to 80°C

Humidity

Operation	5 to 95% RH, Non-Condensing
Storage	5 to 95% RH, Non-Condensing

Shock & Vibration	MIL-STD-810G, Category 24
-------------------	---------------------------

Media

Gasses compatible with
Silicon, Silicone,
Aluminum and Buna-N

Maximum

Environmental Pressure	100psia (690kPa absolute)
------------------------	---------------------------

Minimum

Environmental Pressure	0.50psia (3.45kPa absolute)
------------------------	-----------------------------

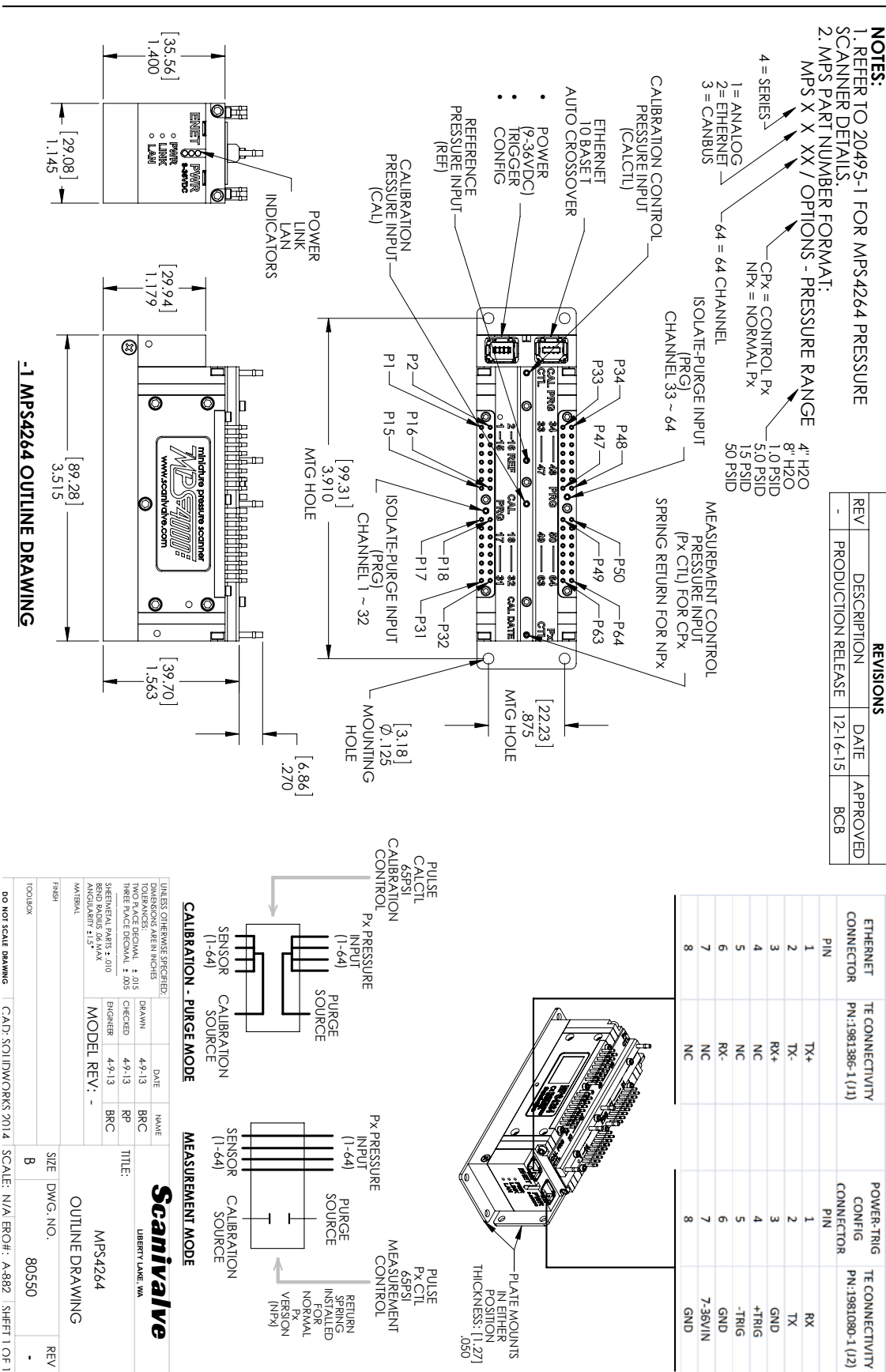

FIGURE 1-1: MPS4264 DIMENSIONAL DRAWING

80555-1

REVISIONS			
REV	DESCRIPTION	DATE	APPROVED
-	INITIAL RELEASE	6-10-19	AA
A	UPDATE MOUNTING PLATE DIMS	2-22-22	AA

NOTES:
 1. DIMENSIONS LISTED ARE INCH [mm]
 2. REFER TO MPS DATA SHEET FOR PRESSURE SCANNER SPECIFICATIONS.
 3. REFER TO 20425-1 FOR ASSEMBLY DETAILS.
 4. ELECTRIC ACTUATION POWER REQUIREMENTS: 18-24VDC 2A
 5. TIME REQUIRED TO SWITCH STATE: 15 SECONDS
 6. TEMPERATURE LIMITS: 0C TO 70C
 7. VIBRATION LIMITS: MILSPEC 810G CURVE H
 8. MOUNTING PROVISIONS AVAILABLE

MPS PART NUMBER FORMAT:
 MPS X X XX / OPTIONS - PRESSURE RANGE
 4 = SERIES
 2 = ETHERNET
 64 = 64 CHANNEL
 EPX = ELECTRIC DRIVE

ETHERNET 10 BASE T AUTO CROSSOVER
 INDICATORS
 POWER (9-36VDC) TRIGGER CONFIG
 ISOLATE-PURGE INPUT (PRG) CHANNEL 33 ~ 64
 MOTOR DRIVE
 REFERENCE PRESSURE INPUT (REF)
 ISOLATE-PURGE INPUT (PRG) CHANNEL 1 ~ 32
 CALIBRATION PRESSURE INPUT (CAL)
 4" H2O
 8" H2O
 1.0 PSID
 5.0 PSID
 15 PSID
 50 PSID

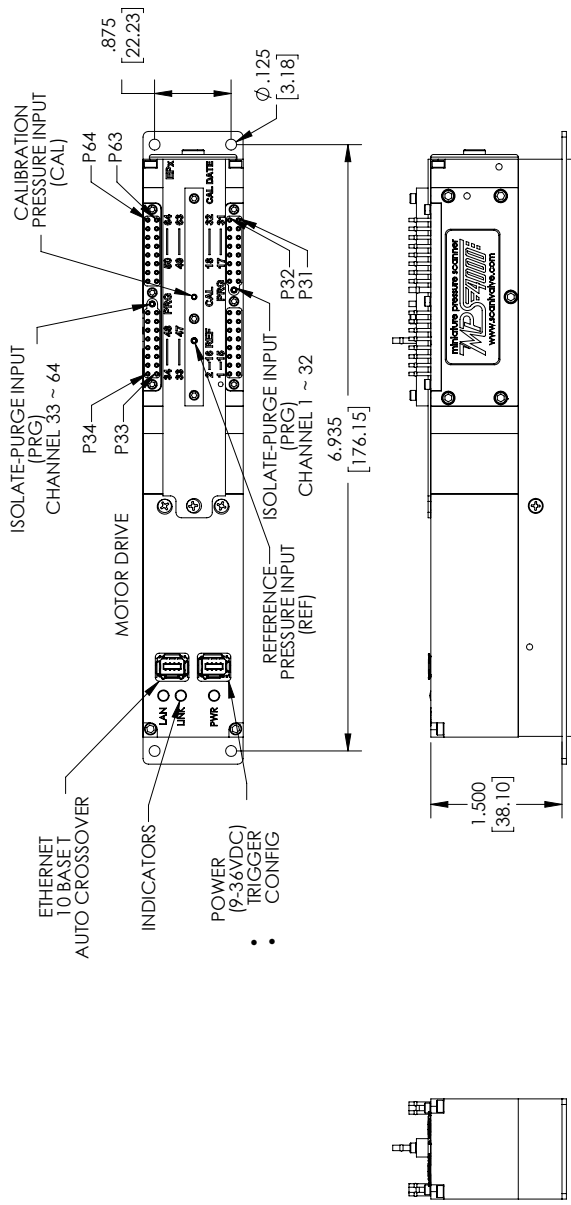

- 1 MPS4264/64EPX ELECTRIC DRIVE OUTLINE DRAWING

DATE	NAME
12-31-18	BRC
CHECKED	12-31-18
ENGINEER	12-31-18
TITLE: MPS4264/64EPX ELECTRIC DRIVE OUTLINE DRAWING	
SIZE	DWG. NO.
B	80555
REV	A

Scanivalve
 LIBERTY LAKE, WA

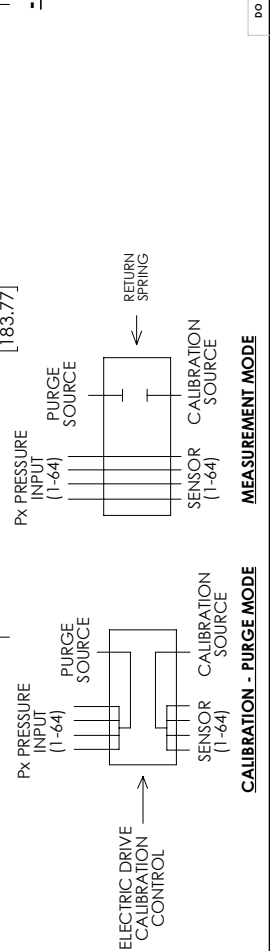

DO NOT SCALE DRAWING
 CAD: SOLIDWORKS 2017
 SCALE: N/A
 ERO#: SHEET 1 OF 1

FIGURE 1-2: MPS4264/EPX DIMENSIONAL DRAWING

SECTION 2: INTRODUCTION

OVERVIEW

The MPS4264 is a 64 channel, intelligent, miniature pressure scanner. Each MPS4264 series scanner incorporates 64 individual piezoresistive pressure sensors. In addition to the pressure sensors, the MPS4264 integrates all of the electronics for the analog-to-digital (A/D) conversion process and a processor running a DSP operating system supporting the engineering unit conversion process and all communications overhead. The integral DC/DC converters allow for a single 9-36Vdc power input. Communications and data output is via Ethernet, and RS-232 communications are included for backup and troubleshooting. All 64 pressure sensors share a common reference manifold in the center of the module. The MPS4264 module has two pneumatic valves, each servicing 32 pressure sensors. The valve supports four logic states:

1. Measurement
2. Calibrate
3. Purge
4. Isolate

The valve state is selected by either applying control pressures (applicable to standard pneumatic units) or via software command (applicable to electric actuation units).

The MPS4264 is the first product designed by Scanivalve to leverage the proprietary "Dynamic CALZ" function. The function effectively nulls the zero offset of the entire analog-to-digital conversion process with every single scan. This feature produces extremely stable sensor outputs and virtually eliminates all zero drift in the system. With negligible zero drift over time or temperature, the traditional pneumatic zero correction that was frequently required is now greatly reduced.

MODULE CONFIGURATIONS

The MPS4264 is the initial pressure scanner in the MPS4000 series of pressure scanners. All variants in the series use the same sensors and valves. However, the electronics are different for each, and the overall form factor is slightly different for each model. Because the interface, form factor, and function is different for each variant they will be covered in separate documents. There are several options that, for the most part, apply to all three variants.

PRESSURE RANGE

Each MPS module can be configured to support measurement ranges from 4"H₂O to 50PSID.

VALVE ACTUATION

There are three options for actuating the valves in the MPS4000 series. Each one is optimal for a specific application. These configurations are:

Pneumatic "CPx" - This option places a pneumatic input on each end of the valve. 65psi control pressure applied to each of the ports individually determines the position of the valve. This is optimal for any MPS4000 module that will be replacing legacy ZOC33 modules as the 65psi control pressures are common to both.

Pneumatic "NPx" - This option uses a pneumatic actuator on one end and a spring on the opposing end. The spring is constantly driving the valve into the measurement, or "Px" mode. This requires no control pressure to scan and collect data. The opposing pneumatic control pressure required is 90-120psi. This is optimal for any application with DSA3200 series modules requiring the same control pressure range.

Electric "EPx" - This option uses an internal motor and gear to cycle the valve against a spring on the opposing end. The spring will maintain pressure against the valve, however the position will be dictated by the position of the internal gear. A software command must be issued to change the position of the valve. This is optimal in applications where pneumatic control pressure is inconvenient or unavailable.

PRESSURE SENSORS

The 64 pressure sensors in the MPS4000 series are mounted in groups of four to custom designed ceramic bases. Sixteen (16) ceramic bases, or "sticks" are RTV'd to a printed circuit board to create a 32 channel set. This architecture allows for a single four-channel sensor "stick" to be replaced at the factory if needed. It also provides double isolation from any mechanical stresses that may be present in the assembly.

Each sensor PCB includes four (4) digital temperature chips and four (4) RTD's. The RTD's are for use in analog environments (MPS4164) while the digital temperature chips are used in the intelligent environments (MPS4264). The digital temperature chips have been mapped to determine which pressure channels they are most representative of and are used in the pressure engineering unit conversion process.

For every MPS4000 series module, two sensor circuit boards are mounted back to back in the central housing. The core of the housing is an open volume that is used as a

common reference pressure for all 64 channels. The design places the sensors deep in the center of the module. Being located in the center of the module protects the sensors as much as possible from rapid temperature changes and allows for very accurate temperature compensation.

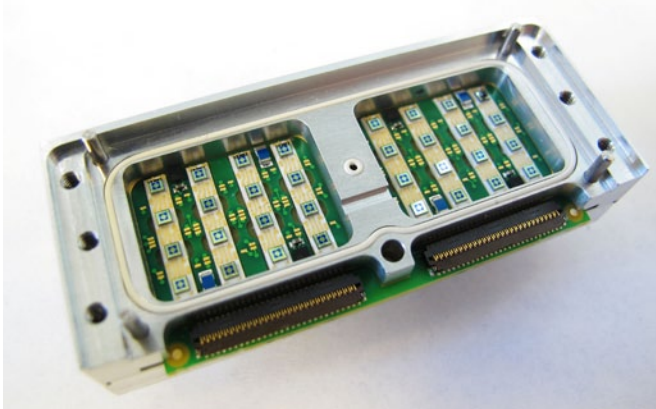

FIGURE 2-1: PRESSURE SENSOR OVERVIEW

PNEUMATIC VALVE

A single MPS4000 series module integrates two pneumatic valves, each supporting 32 channels. The valves are located directly under the pressure inputs on each side of the module. The valve supports four pneumatic states in two physical states. In the “measurement mode” pressures are directed in from the measurement inputs to the individual pressure sensors. The other physical state, “calibrate mode” provides three pneumatic states. They are:

1. Calibrate - A single pressure applied to the “CAL” port is directed to the positive side of all 64 transducers.
2. Purge - Purge pressures applied to the two purge inputs are directed out the 64 measurement ports to clear any debris, particulate or moisture from the inputs lines.
3. Isolate - The 64 pressure transducers are isolated from the input lines and from the purge pressure.

The valve design is a sliding-type valve. An aluminum shuttle populated with O-rings cycles back and forth between two positions to achieve each of the physical states. An interface between the sliding O-rings and the aluminum stationary portion of the valve is a proprietary compound that is extremely low friction. The O-rings are supported completely to prevent any deformation during a state change. Additionally, the valve shuttle is supported on ball bearings to provide minimal friction and maximum support. This design allows for low actuation forces, minimal “stiction” - meaning the actuation forces do not noticeably increase over time, and minimum wear. Samples of the valve design were tested to over 1,000,000 cycles without any maintenance.

As a subset of the pneumatic option, the valve can either be a spring-driven “NPx” version or a “CPx” bidirectional pneumatic driven version. The advantage of the “CPx” pneumatic version is that it retains the same 65psi control pressure that legacy ZOC33 analog pressure scanner modules used. Two control pressure inputs are used, Px CTL and CAL CTL. In the case of the spring-driven “NPx” version a spring is constantly driving the valves into measurement, or Px mode. This requires no control pressures to be present for measurement and also prevents the valve from unexpectedly or undesirably moving out of measurement mode. The “NPx” version requires 90-120psi control pressures which is common to the DSA line of products that Scanivalve produces.

The electric valve “EPx” configuration utilizes an internal motor and gear to change the valve position. Similar to the pneumatic “NPx” version, a spring is located on the opposite end that drives the valves into measurement mode. However, the ultimate position of the valve is determined by the motor and gear. A simple software command can be used to change the valve state in the EPx configuration. This is optimal for applications where pneumatic control pressures are inconvenient or unavailable. The commands available to the EPx version can be found in the Section 5 - Software under “Electric Valve Commands” (page 78).

All versions of the MPS4264 incorporate an optical sensor used to determine the position of the valve. This can be queried through the MPS’s software interface. The pneumatic configured MPS’s valve position sensor only confirms that the valve is fully in the measurement mode or not. It does not verify with 100% certainty that the valve is in the calibrate mode.

ELECTRONICS - PNEUMATIC VALVE

The MPS4264 has seven (7) unique printed circuit boards including two (2) flexible circuits. Under the cover on the end of the module is the I/O Board (Input-Output) which supports the power input and communications. This board has all of the interface electrical connectors including the Ethernet and Power connectors (which also supplies RS-232 and external triggering leads). It is also where the DC-DC power supply is located. The I/O Board is connected to the processor board via a flexible circuit.

The Processor Board is where the modules memory and processor reside. This board is located along the very bottom of the module inside of the lower aluminum cover. Above the Processor Board is the A/D board which is connected by a rigid parallel board-to-board connector. The A/D board is where all 16 A/D converters are located

(one A/D per 4 transducers) as well as all of the multiplexing and sensor excitation.

The A/D board is connected to each of the two Sensor board with two flexible circuits each. Each connection handles a quadrant of 16 channels. The Sensor board, as discussed earlier has 32 individual pressure sensors mounted on ceramic bases.

The last circuit board is the valve position sensor board. The single valve position sensor resides in a machined cavity of the valve/side plate and optically checks the position of the valve shuttle. It connects directly to the processor board using a miniature connector.

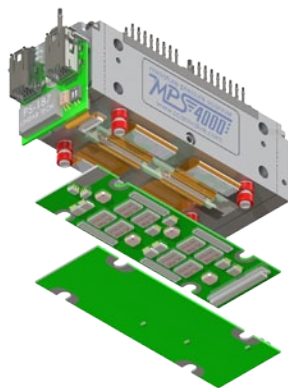

FIGURE 2-3: ELECTRONICS EXPLODED VIEW -NPX/CPX

ELECTRONICS - ELECTRIC VALVE

The MPS4264/EPx utilizes the same processor, A/D board, sensor boards, and valve position sensor board.

The I/O board has expanded to include the necessary components to switch and operate the internal motor. This board, along with the motor and gear assembly, has caused the end cover to be redesigned in order to accommodate for the additional parts. The I/O board is connected to the processor board using a longer flexible circuit.

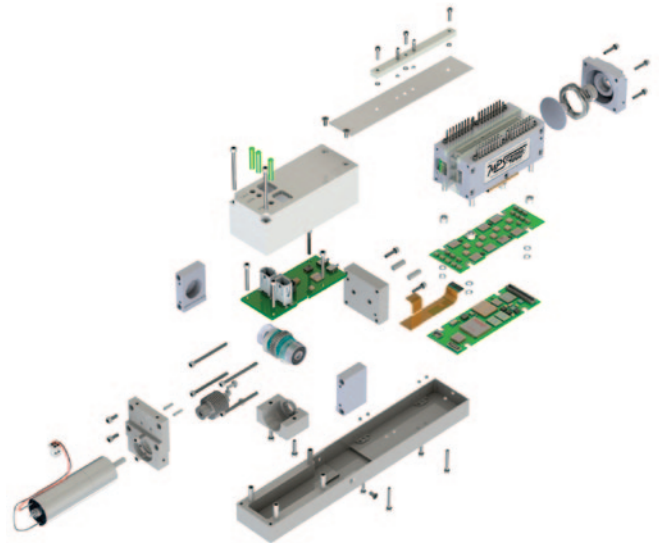

FIGURE 2-4: ELECTRONICS EXPLODED VIEW - EPX

PNEUMATIC INPUTS

For added convenience and flexibility, all pneumatic inputs on the MPS4000 series use removable headers. There are three separate manifolds, two headers for the 64 input ports and a third manifold for the CAL, REF and Control Input(s). The purge supply pressure is also applied through each of the two measurement manifolds. The manifolds are held on with three captive screws each. Under the CAL/REF/CTL manifold is an ID plate that will be free when you remove the manifold. Take care to not lose this plate or the O-rings that are retained by it.

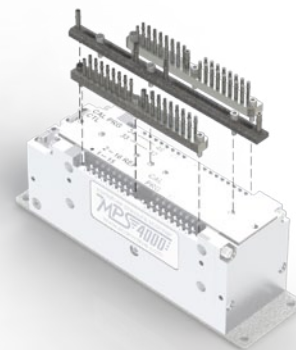

FIGURE 2-5: PNEUMATIC INPUT HEADERS

POWER & ETHERNET CONNECTIONS

The MPS4264 has its power and Ethernet connections located on one end. The power connection also serves as an external trigger input and a serial connection. LEDs are positioned in a recessed cavity between the two connectors to indicate power, link and activity. Both the power and the Ethernet connector are TE Connectivity “Mini IO” series but are polarized differently to prevent improper connections. The connectors are latching to prevent vibration from loosening the connections.

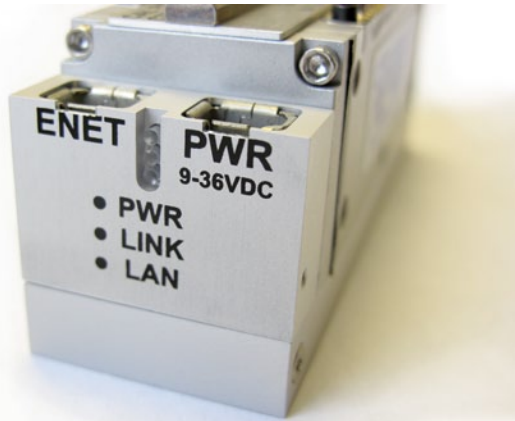

FIGURE 2-6: POWER & ETHERNET CONNECTIONS - NPX/CPX



FIGURE 2-7: POWER & ETHERNET CONNECTIONS - EPX

[INTENTIONALLY LEFT BLANK]

SECTION 3: OPERATION

UNPACK & INVENTORY

When you first unpack the MPS4264 module, begin by inspecting and inventorying the contents of the package. If any visible damage is immediately noticed or if any contents are missing, contact Scanivalve before proceeding. As a minimum, MPS4264 modules are shipped with the following contents:

1. MPS4264 module
2. Protective case
3. 155625 Power cable with flying leads
4. 156110 Ethernet RJ45 adaptor cable
5. MPS4264 resource disk (USB thumb drive) containing backup files and calibration information.

MOUNTING

The MPS4264 includes a stainless steel mounting plate. Using three #2-56 screws it can either be mounted to the bottom of the module or to the side. The mounting plate is 0.060" (1.5mm) thick with four 0.125" (3.1mm) holes in it. See Figure 3-1 for hole spacing, and Figures 3-2 and 3-3 for instructions for attaching the mounting plate to the MPS module. The MPS can be mounted in any orientation.

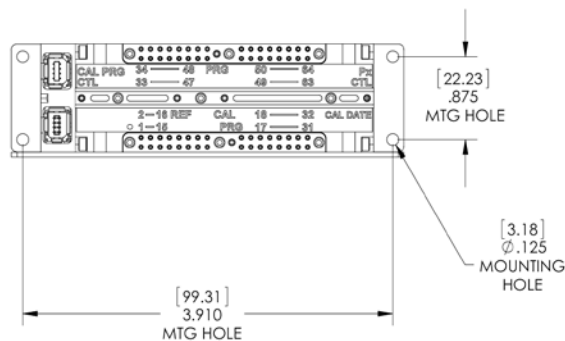

**FIGURE 3-1: MOUNTING PLATE DIMENSIONS
- NPX/CPX**

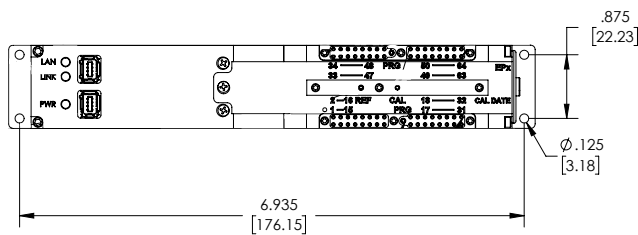

FIGURE 3-2: MOUNTING PLATE DIMENSIONS - EPX

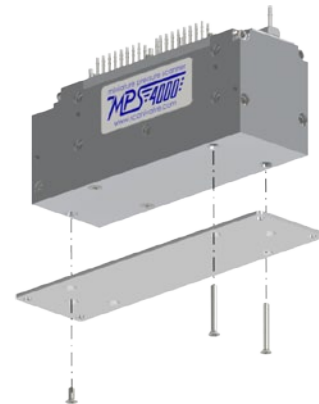

FIGURE 3-3: MOUNTING PLATE, BOTTOM

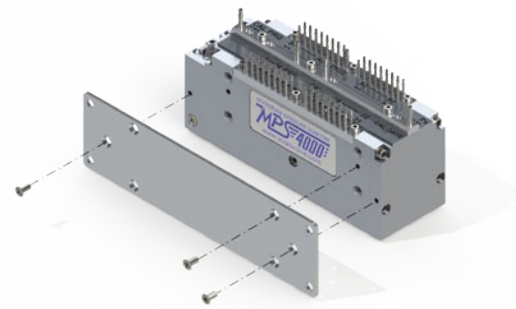

FIGURE 3-4: MOUNTING PLATE, SIDE

ENVIRONMENTAL CONSIDERATIONS

The MPS4264 series is designed to withstand normal industrial, flight test, educational, wind tunnel or similar applications. The module is not water proof and it should be protected from any splash, spray, or mist. If any moisture gets spilled or splashed on the MPS module, wipe it dry immediately to prevent damage to the module.

The MPS module should not be mounted in a location where it may be subjected to extreme temperature shifts or ambient temperatures outside limits defined in "Section 1: Specifications" on page 7. Keep in mind that the internal temperature of the module may run 5°C - 20°C warmer than ambient temperature. This temperature increase is accounted for in the calibration tables. The temperature specification listed is in relation to the ambient temperature.

If the MPS module must be used in an environment outside the guidelines above, it should be installed in a Thermal Control Unit (TCU). This is a rugged enclosure incorporating a heater or cooling fittings to protect the MPS module.



CAUTION! Mounting the MPS module inadequately or in an environment that does not conform to the recommendations can result in permanent damage to the module.

WARM-UP

Because of the design of the MPS4264, the accuracy is only minimally impacted by the device warming up after initially being powered. Figure 3-4 below shows a sample 5psi module being powered on. Pressures from 3 channels are shown along with the module temperature. As indicated in the graph, the first 15 minutes of warm up produces the only noticeable change in the pressure readings. The module can take up to 3 hours to fully warm up (in a 25°C ambient environment) but throughout that warm-up the pressure readings are very good. It is recommended that the module be allowed to warm up for a 15-30 minutes before collecting data, but this is not mandatory. If time allows, the warm-up period should be extended to 60 minutes for most applications.

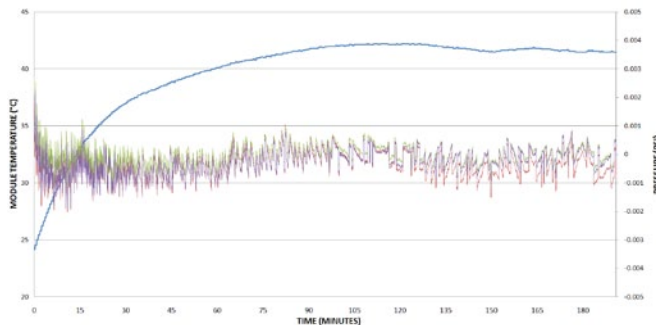

FIGURE 3-4: TEMPERATURE & PRESSURE THROUGH MODULE WARM-UP

COMMUNICATIONS

The MPS module is designed primarily for Ethernet communications. This provides a means to configure the MPS module as well as scan and collect data from the module.

A serial RS-232 connection is also supported. The serial connection is designed to provide emergency communications with the module in cases where an Ethernet connection cannot be established. If the internal memory in the MPS is corrupted in any way, the serial connection allows the user to format the memory and restore the operating files.

SERIAL COMMUNICATIONS

Every MPS4264 module has an RS-232 serial output. It is

available through power connector on pins 1, 2 and 3. The wiring diagrams can be found in “Appendix F - Cable Drawings and Pinouts” on page 92. Settings for establishing a serial connection to the MPS4264 module are as follows:

Bits per second: 9600 BAUD
Data bits: 8
Parity: none
Stop bits: 1
Flow control: none

Once a connection is established any of the commands listed in “Section 5: Software” on page 35 can be sent to the module. The only limitation is that the a SCAN cannot be initiated via the serial connection and scan data will never be returned via the serial connection. Most importantly, through the serial connection, the module’s “Group IP” settings, including the IP address, can be viewed and set. The module’s internal memory can also be formatted and restored through a serial connection (see “Formatting the Flash Disk” on page 80 for this procedure.)

Two power/serial cables are available for the MPS. They are:

P/N 156085: “Premium” Mini I/O male to Mini I/O male power/serial/trigger cable
P/N 155625: Mini I/O Trigger/Power cable with flying leads

The cable listed as “Premium” versions use a highly-flexible, silicone coated cable that is the smallest possible diameter (0.156”, 4mm).

ETHERNET COMMUNICATIONS

The MPS4264 has one Ethernet connection, 10/100Base-T with MDIX auto-crossing. This is the primary means of communications with the MPS. All MPS4264 modules use a TE Connectivity “Mini I/O” series connector for the Ethernet connection. This is a latching connector to prevent the connector from becoming unseated when subjected to vibrations. Shielded Category 5e cable or better is recommended for all Ethernet connections. Several variations of Ethernet cables using the TE Connectivity “Mini I/O” connector are available from Scanivalve. Depending on the application, different cables may be required.

ETHERNET CABLES:

P/N 155635 Mini I/O male to RJ45 male patch cable
P/N 156062: “Premium” Mini I/O male to RJ45 male patch cable.
P/N 156110: Mini I/O male to RJ45 female receptacle extender cable.

P/N 156091: “Premium” Mini I/O male to Mini I/O male patch cable (MPS to ES4000 Switch)

Cables listed as “Premium” versions use a highly-flexible, silicone coated cable that is the smallest possible diameter (0.156”, 4mm). Maximum cable length for any of the Ethernet cables is 200 feet. For additional information on establishing an Ethernet connection with the MPS, see “Setting Up an Ethernet Connection” on page 1816.

CLIENT/HOST OPTIONS

Once the module has been connected and the IP address has been configured, communications can be established with the MPS module. Communications can be made through several software packages including:

- PC - TCP/IP
- PC - UDP
- PC - ScanTel (Scanivalve PN: 155406-01)
- PC - LabVIEW
- PC - Windows HyperTerminal

PC - TCP/IP

The user may write their own TCP/IP interface using the software specification portion of this manual. This interface should allow the user to:

- Issue commands to any or all MPS modules on the network.
- Display returned information or scan data from the MPS module(s).
- Write returned information or scan data to the client/host in TCP/IP format.

PC - UDP

The MPS provides a dual-output function in which data can be output simultaneously out via a FTP connection and a UDP broadcast data stream. This allows for great flexibility in the configuration of the data collection. It allows users to configure a system such that data can be monitored “real-time” via the UDP stream and collected reliably via the FTP data transfer.

PC - SCANTEL

ScanTel is a free communications utility designed by Scanivalve to communicate with Scanivalve products including MPS4264 modules. It is a text based, command line program that allows users to connect to a single MPS module and modify the configuration variables, upload or download coefficients and collect data in both TCP/IP and UDP format.

PC - LABVIEW

The MPS4264 has been developed specifically with a simplified LabVIEW interface in mind. This allows the user

to easily create a custom graphical interface with the MPS to configure the unit, collect and display data. For detailed information on setting up a LabVIEW interface with the MPS, see “Appendix C - LabVIEW Client Example” on page 88. Free sample VI’s are available to assist with creating a custom LabVIEW interface.

PC - HYPERTERMINAL

HyperTerminal is a Windows program included as part of Windows 2000, XP and Vista Operating Systems. This program permits a user to connect to a single MPS module, modify the configuration variables, upload or download coefficients and collect data. HyperTerminal provides a means for both Serial RS-232 and Ethernet connections. It is a text based command line program. HyperTerminal emulators like “PuTTY” can be downloaded for free from various sources online if HyperTerminal is not available.

FTP

The MPS4264 can transfer scan data via FTP to a FTP server. The user may set up any suitable server or NAS capable of running as a FTP server. This provides a secure, reliable data connection to generate data files directly on an FTP server.

SETTING UP AN ETHERNET CONNECTION

Before an Ethernet connection can be established the IP address need to be configured. This can be done manually with a “static” IP address or automatically using a “dynamic” IP address automatically assigned to the MPS by a DHCP server. If you will be using a “static” IP address, then the IP address of the MPS must be manually set by the user. The IP address assigned to the MPS must be compatible with the network/host computer. If you will be using a “dynamic” IP address, the MPS must be both configured to obtain an IP address automatically and it must be on a network with a DHCP server present.

USING A STATIC IP ADDRESS

If you choose to use a static IP address, you must manually set the IP address of the MPS. The IP address you choose to use must be compatible with the network the MPS is being connected to. If you are simply connecting the MPS directly to a host computer, then the IP address of the MPS and the host computer must be compatible and should both be configured manually. The range of compatible IP addresses is defined by the subnet mask. The standard default subnet mask is 255.255.0.0. This default subnet mask requires the IP address of the module and host computer must share the first two octets, or sets of numbers. The third and fourth octets of the IP address is variable, although it is recommended that the third octet also be shared between the host computer and the module. The subnet mask digits of “255” define that the two IP addresses must have matching digits in those positions and the subnet mask digits of “0” allow the two IP addresses to have unique values for those octets. No two devices on a single network can share the same IP address. Below are some examples of compatible IP addresses.

Example of matching the first three octets:

Subnet mask: 255.255.255.0
Host computer: 191.30.90.100
MPS module: 191.30.90.125

Example of matching the first two octets:

Subnet mask: 255.255.0.0
Host computer: 191.30.1.100
MPS module: 191.30.90.125

Example of NON-COMPATIBLE IP addresses:

Subnet mask: 255.255.255.0
Host computer: 191.30.5.1
MPS module: 191.30.90.5

When connecting the MPS and configuring the network, you can choose to either change the IP address of the MPS module to match the network, or change the IP address of your host computer to be compatible with the MPS module. If you choose to change the IP address of the host

computer to be compatible with the MPS, then:

The IP address of a Windows XP host computer can be changed under:

Control Panel -> Network Connections -> Local Area Network -> Properties -> Internet Protocol (TCP/IP) -> Properties

The IP address of a Windows 7/10 host computer can be changed under:

Control Panel -> Network and Sharing Center -> Local Area Connection/Ethernet -> Properties -> Internet Protocol Version 4 (TCP/IPv4) -> Properties

MPS4264 modules are shipped with a preset IP address that uses the following format:

MPS4264: 191.30.90.XXX
(Where “XXX” is the last three digits of the unit’s serial number.)

The MPS4264’s IP address is set with the “IPADD” variable in the IP Group of variables. This can be changed through an existing Ethernet connection or through a serial connection. If an existing Ethernet connection can be established (by changing the host computer’s IP address or some other means) it is the preferred method. If it is not possible, then a serial connection can be established with the MPS. **If the IPADD variable is changed either through an Ethernet connection or a serial connection, the new address will not be effective until a “SAVE IP” command has been issued and power has been cycled.** For more information on the IPADD variable, “Set IP Address of the MPS (IPADD)” on page 66. More information on establishing a serial connection can be found in “Serial Communications” on page 16. Once the IP address of the MPS and host computer have been set to be compatible, the connection should be tested. The best means of doing this is to “ping” the MPS using the host computer’s command prompt.

CHANGING THE IP ADDRESS

The following procedure will change the IP address of the MPS4264.

1. Establish a connection to the MPS4264 using a serial or Ethernet connection. Software that can be used is discussed in the previous section.
2. Issue the command:
LIST IP<ENTER>
3. The IP address and communication variables will be displayed.
4. Issue the command:
SET IPADD xxx.xxx.xxx.xxx<ENTER>
where **xxx.xxx.xxx.xxx** is the IP address desired.

5. Issue the command:
LIST IP<ENTER>
Confirm that the IP address set is correct.
6. Issue the command:
SAVE IP<ENTER>
The IP address has now been saved. Wait for the “>” to return before continuing.
7. Issue the command:
REBOOT<ENTER>
- or - Cycle the ECM power.
The MPS will now boot with the new IP address.

USING A DYNAMIC IP ADDRESS

The MPS can be setup to have a IP address dynamically assigned from a DNS server using DHCP. When the IP address is set to 0.0.0.0 then DHCP is used. When DHCP is active, the MPS’s DNS name is used to connect to the unit. The DNS name is defined by the variable NAME in the LIST IP group.



Remember that any changes to the variables in the LIST IP group require a SAVE IP command be issued and the MPS must be restarted for them to take effect.

The DHCP server will supply an IP address to the MPS for a period of time, called a lease. The MPS continues to broadcast discovery packets every 5 seconds until the DHCP server responds with an “offer.” Network communication is not possible to the MPS unless it is in the “IP is Now Leased” state. See Figure 3-6 below. The lease is usually granted for 24 hours. This sequence also applies to renewals that typically occur every 12 hours.

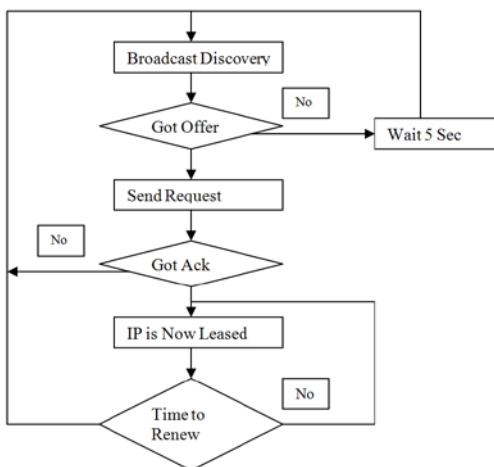

FIGURE 3-7: DHCP LEASING PROCESS

The MPS only issues a discovery packet to the DHCP server. It does not communicate with any DNS server that may be attached to the network. Therefore when it is desired to use a name in place of an IP address, the network must be

set up so that the DHCP server retrieves the name from the DNS server. This is referred to as DNS dynamic record update. The MPS does furnish a requested name to the DHCP server so that it may pass the name on to the DNS server.

For Windows Server based networks, Figure 3-8 shows the settings for automatic dynamic update of the DNS server. The exact method for making these setting will vary based on the operating system and operating system version.

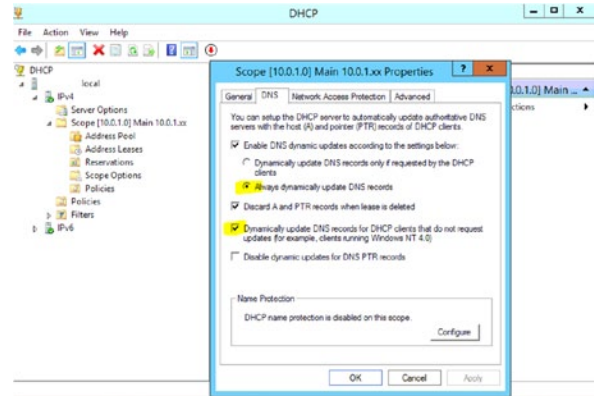

FIGURE 3-8: WINDOWS SETTINGS FOR AUTOMATIC DNS SERVER UPDATES

Once the IP address of the MPS and host computer have been set to be compatible, the connection should be tested. The best means of doing this is to “ping” the MPS using the host computer’s command prompt.

WEB SERVER: CONNECTING

The MPS4264 is a single user web server which provides a simple method for communication, configuration, and data collection from virtually any host computer. It requires no additional software be installed on the host computer and provides a simple graphical interface for the user.

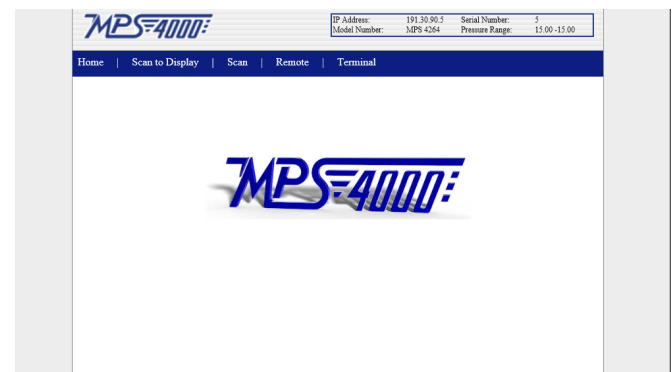

FIGURE 3-9: WEB SERVER WELCOME SCREEN

The web server has been tested with several web browsers

to verify functionality and compatibility. Those that were tested are:

Internet Explorer 10 (and later)
Microsoft Edge

To connect to the MPS4264's web server, simply open one of the supported browsers. In the address bar, enter:

xxx.xxx.xxx.xxx

(where xxx.xxx.xxx.xxx is the IP address of the MPS).

Once connected, the web server's welcome screen will be displayed.

At the top right corner of the screen, basic module information will be displayed. This will include IP address, Model Number, Serial Number, and Nominal Pressure Range.

WEB SERVER: CONFIGURING SCAN SETTINGS & SCANNING DATA TO A FILE

Once you have connected to the MPS4000 and have the home page displayed, you may click on various links to perform different tasks. On the blue navigation bar select the "Scan" link. You will get the following screen:

FIGURE 3-10: WEB SERVER SCAN CONFIGURATION SCREEN

The left column of this page are the Scan Settings in the MPS.

There are five configuration variables that you can set from this column. They are:

SCAN RATE PER CHANNEL: This sets the data output rate in samples/channel/second (Hz).

FRAMES PER SCAN: This sets the number of samples that will be output for each time a "SCAN" command is received (cannot be 0).

UNITS: This is a selection box, allowing you to select the pressure units the data will be output in.

TRIGGERING: This is a selection box, allowing you to select the method that a each frame of data is initiated by. There are two options:

INTERNAL - A scan is initiated, and subsequent frames of data are scheduled using the MPS's internal clock.

EXTERNAL FRAME - A scan is initiated, and subsequent frames of data are acquired using an external trigger.

Additionally, there is a "FORMAT" drop-down box allowing you to select the type of data collection using different methods. Those options are:

EXCEL (.CSV): This generates a .CSV file that can be opened or saved to the host computer. This file will contain ASCII data in a column format, with a column of data for each pressure and temperature channel. *This data collection transfer is ASCII, and is limited to certain scan rate restrictions.*

ASCII (.TXT): This generates a .txt file that can be opened or saved to the host computer. This file will contain ASCII data in a single "scrolling" format, with all data from each frame of data printed out below the previous. *This data collection transfer is ASCII, and is limited to certain scan rate restrictions.*

Binary (.DAT): This generates a .dat file that will be saved to the host computer. This file will be binary data, and can be converted to an ASCII format as a post processing task.

STATISTICAL BINARY (.DAT): This generates a .dat file including pressure data and statistical analysis data that can be saved to the host computer. This file will be binary data that will need to be converted to an ASCII format using a post processing task. See "Statistical Scan Option" on page 26 for more information.

There are two other buttons in the Scan Settings column: SAVE and SUBMIT. If you have altered any of the values in Scan Settings column, you must use the SUBMIT button to submit these changes to the MPS. These settings will be maintained until they have been altered and submitted, or until the module is power cycled. If you would like to save these settings through a power cycle, please use the SAVE button.

The right column of this page are action buttons that perform the following:

VALVE POSITION: This button will update the current valve state to show the current state of the MPS. This state will show in text adjacent to the button. *Note: The valve state does not automatically update. You must click the VALVE POSITION button for an update.*

ZERO CAL: This will perform a Zero Calibration (CALZ). Text in a red box will appear at the bottom of the screen. Please do not navigate away from this page during a Zero Cal. All buttons will become unavailable during a Zero Cal, and will be enabled after the Zero Cal is completed.

SCAN TO FILE: This button will initiate a SCAN sequence based on the configured Scan Settings in the left column. This button will submit any changes to these settings and begin data collection.

WEB SERVER: SCANNING DATA TO THE SCREEN

The webserver allows for the ability to scan and collect data to the screen. On the blue navigation bar, click on the “Scan To Display” link. You will get the following screen:

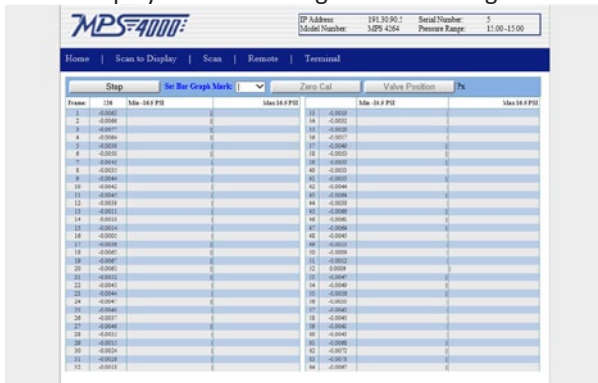

FIGURE 3-11: WEB SERVER SCAN TO DISPLAY

Click the “SCAN” button. The bar graphs will display the pressure as frames of scan data are sampled. Click on “STOP” when finished. There are three important notes about the “Scan to Display” function and how the bar-graph works.

- 1) The bar graph will never update faster than 1 Hz. If the MPS is set to scan at a higher rate than this, the data collected between the display refreshes are ignored and discarded.
- 2) When the “Scan to Display” function is used, the “FPS” variable is ignored. The MPS will continue to scan and the bar graph will display data until the STOP button is clicked no matter what the FPS variable is set to.
- 3) The bar-graph is automatically scaled based on the highest pressure value that is being displayed.

The size and scale of the “marks” in the bar graph can be set by clicking “Set Bar Graph Mark.” This only effects how the bar is displayed in the bar graph and has no effect on the data or scaling of the graph.

You will also have the options of performing a Zero Cal, or query the Valve Position from this page. You cannot perform these while the MPS is actively scanning.

ZERO CAL

The MPS4264 was designed for maximum sensor stability

and extensively tested for operations with no zero correction calibrations. For many applications the ‘Zero Cal’ (aka CALZ) feature will not be needed. Every sensor behaves in a unique way so it is impossible to outline specific guidelines on when the CALZ will need to be used, but for most cases where the module is operating between 15°C and 40°C no CALZ should be needed. Scanivalve recommends monitoring and checking the module’s readings with zero pressure applied to determine if sensors have drifted and if a CALZ needs to be performed.

WEB SERVER: “REMOTE” SCREEN

The MPS4264 incorporates a feature to allow multiple MPS4264 units to communicate with one another, allowing certain commands to be sent to a single “master” unit and then rebroadcast out to the selected “slave” units. This makes the user interface much simpler and allows for more accurate synchronization between units. This function uses the network multicast feature to establish an MPS4264 group or “cluster.” While the multiple-unit commands and interface is limited through the web server, the “Remote” tab on the web server allows you to search for any MPS4264 scanners that are in the same “cluster” as the MPS you are currently communicating with is.

To search for MPS scanners that are in the same “cluster” as your master device, simply click “Find Remote Devices” in the upper navigation bar. A pop-up screen will appear advising you that the master is searching for slave units. Once the pop-up closes, you will be returned to the web server. If any modules are discovered in the cluster, they will be listed including their serial number, IP address and pressure range as shown in Figure 3-13 below.

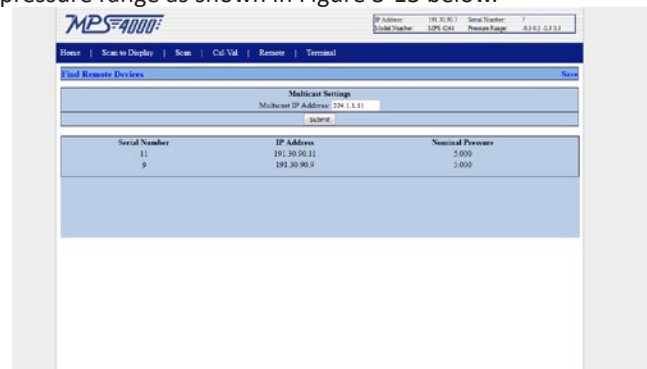

FIGURE 3-13: WEB SERVER REMOTE SCREEN

In addition to searching for other MPS4264’s in the cluster, the “Remote” page of the web server allows you to change the unit’s current multicast address. This can be set in the “Multicast IP Address” field. In order for the change to take effect, you must:

1. Enter the desired multicast address in the field
2. Click the “submit” button

3. Click the “Save” link at the top of the screen
4. Wait for the save to complete (typically 15 seconds)
5. Cycle power on the MPS.

Once this has been completed the MPS4264 will be configured with the new multicast address.

For more information on the multicast function and working with multiple MPS units at the same time, see “Multiple Unit Operations” on page 24.

WEB SERVER: “TERMINAL” SCREEN

The MPS4264’s web server integrates a “terminal” emulator screen allowing the user to send simple text commands to the scanner. While most of the configuration variables in the module are accessible through the several GUI web server screens, not every variable in the MPS can be queried or changed through the graphical portions of the web sever. For the remainder of the variables that are not accessible, the “terminal” screen provides a simple means to check and change every variable in the MPS. LIST commands can be sent to check the current setting of relevant variables and any command can be sent to the MPS through the web server’s terminal.

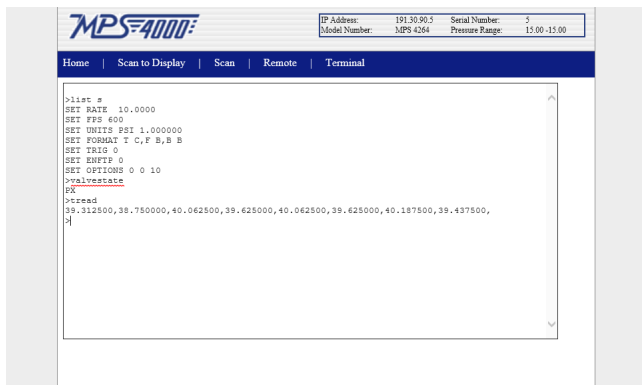

FIGURE 3-14: WEB SERVER TERMINAL SCREEN

There are limitations to the Terminal, however. These limitations include the inability to perform a SCAN or CALZ. These limitations will not allow you to scan and collect data to the screen in Terminal, or perform a Zero Calibration.

WEB SERVER: ELECTRIC VALVE OPTIONS

The MPS4264 web server will automatically adjust when an Electric Valve (EPx) module is present. A new bar will appear that includes options that are specific to the MPS/EPx. This bar can be observed in figure 3-15. These options will be present on the “Scan to Display” and “Scan” windows.

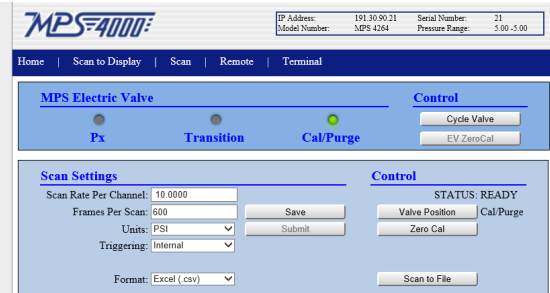

FIGURE 3-15: WEB SERVER ELECTRIC VALVE OPTIONS

The added options include:

CYCLE VALVE: This button will initiate a valve change.

This button is non-specific, and will move the valve from it’s current state to the next.

EV ZEROCAL: This will perform an “ECALZ”, or the electric valve zero cal sequence. The MPS will:

1. Cycle the valve to CAL mode
2. Perform a ZeroCal (Cal/Purge light will flash yellow)
3. Cycle the valve to Px mode

Note: This command is only available when the unit is in PX mode. If you are already in Cal/Purge mode, you can simply use the standard Zero Cal button.

VALVE POSITION: The following indicators will show the present state of the valve. These indicators, unlike the Valve Position status, will automatically update.

PX light: This light will be lit green when the valve state is currently in Px (measurement) mode. If the light is not lit, the valve is not in this position.

TRANSITION light: This red light has two indications: If the light is blinking; the valve is currently in transition to the next state.

If the light is solid; the valve is not moving, and is not in Px or Cal/Purge mode. *Note: If the valve is stopped in transition, pressing the CYCLE VALVE button will return the valve to PX.*

CAL/PURGE: This light will be lit when the valve state is currently in Cal/Purge mode. If the light is not lit, the valve is not in this position.

These options are specific to the Electric Valve configuration and will not be available when using a pneumatic MPS4264 - NPx or CPx.

FTP SCAN DATA TRANSFER

The MPS4264 can transfer scan data using FTP protocol to an applicable FTP server. The user may set up any suitable server or NAS capable of running as a FTP server.

See the section “FTP Variables” on page 76 to configure the MPS4264 for FTP transfer. The conditions of SSD and SST must be satisfied before scanning will start.

When ENFTP is set to one, and a scan is started, the software will attempt to open a file on the FTP server as configured by all of the FTP settings. The time and date that is indicated by the GETTIME command is used in the construction of the file name.

The file that is saved on the server is assembled as follows:

```
<path on server><base data filename><date>_<time>.<type>
```

Where <type> is “.DAT” for binary, “.TXT” for ASCII Text, or “.CSV” for ASCII CSV file.

The file is closed when the scan stops. If the file cannot be opened on the server when the scan starts, the scan is stopped before any data is output and the MPS will report an Error to the Telnet port.

THE BINARY TCP SERVER

The MPS4264 provides a binary TCP server designed to support LabVIEW or any other computer based client. The MPS expects a connection to arrive on port 503. **ONLY ONE CONNECTION IS SUPPORTED FROM THE SERVER** due to socket limitations in the MPS. Additional attempts to connect to port 503 when an existing connection is present will be refused.

To enable the binary server, the SVRSEL variable under LIST M must be set to 2. When the SVRSEL is changed, the MPS must be saved with using a SAVE or SAVE M command. After the save has completed, you must power cycle the MPS for changes to take effect.

The format of the binary packet sent from the binary server is based on the setting of the FORMAT configuration variable parameter B. See “Set Scanning Data Format (FORMAT)” on page 49 description for more information.

COMMANDS

Because all of the configuration settings may be handles via the Telnet server (port 23), the binary server only supports starting and stopping a scan. Sending a 1 will start the scanning and sending a 0 will stop the scanning. The scanning

will also stop if the MPS scan buffer overflows or when the binary client disconnects from the MPS.

Additionally, when a client is connected to the binary server port, a scan command issued via Telnet port causes scanning to start and data to be sent out the binary port.

SCAN DATA

Data sent over the binary server can have three formats: LabVIEW, binary packet, or statistical binary packet. Binary packet is described in “Table 5-5: Binary Data Format” on page 39 and is configure via SET FORMAT B B. Statistical binary packet is described in “Table 5-6: Statistical Binary Data Format” on page 41 and is configured via SET FORMAT B S. The following section describes the SET FORMAT B L configuration.

LABVIEW SCAN DATA

When FORMAT B is set to L, scan data, arranged for LabVIEW, is sent from the MPS to the client in binary form that includes the frame number, the MPS average temperature and the 64 channels of pressure data. All values are sent in floating point format making it easier to handle by the client. Each frame contains 264 bytes or 66 array elements. The table below shows each frame’s format:

Parameter	Number of bytes	Array element
Frame Number	4 bytes formatted as float	0
MPS Average Temp	4 bytes formatted as float	1
Pressure Channel 1	4 bytes formatted as float	2
Pressure Channel 2	4 bytes formatted as float	3
.....
Pressure Channel 64	4 bytes formatted as float	65

EXAMPLE LABVIEW

“Appendix C - LabVIEW Client Example” on page 88 shows an example LabVIEW client interface to the MPS4264 binary server.

BINARY DATA BUFFERING

All binary data output, including the Binary server for LabVIEW, can buffer up to 170 frames of data before the buffer overflows and stops scanning. This allows the host software to gather data from the MPS at a slower rate than the MPS is scanning. However, multiple frames must be read, at once, with each read.

To calculate the maximum time that the client can wait before reading data from the binary server use the following:

Max Delay = (1/MPS Rate) * (Max Frames in Buffer) / 2
 Max Delay = (1/MPS Rate) * 170 / 2
 Max Delay = 85 / MPS Rate

Note: The buffer size in the MPS4264 is 170 frames. However, to handle delays in the network connection only half should be used as a target delay. Thus 85 frames are the maximum frames to hold in the buffer.

MULTIPLE UNIT OPERATIONS

When working with multiple scanners, the operation can be greatly simplified by using the integrated “multiple unit” architecture. When the desired units are configured into “clusters” of modules, a single connection can be established to any one of the modules in the cluster. Once this connection is established, any of the “Multiple Unit” commands can be sent to the master unit which will in turn pass of the command to the other modules in the cluster. This allows many unit to be started scanning, stopped or calibrated all at the same time from a single command sent to a single MPS4264 unit.

The MPS4264 uses the network multicast feature to establish a MPS4264 device cluster. In all cases the user connects to one MPS4264. This device becomes the master device. This master then passes the relevant commands on to the other devices that are members of the device cluster. Each MPS4264 has the ability to be a master or slave.

The membership of a MPS4264 into a cluster is established by setting the variable MCAST to the same multicast address. All MPS4264 devices with the same MCAST setting become members of the same MPS4264 cluster. Multiple clusters may exist on the same network. Multicast addresses are limited to the range from 224.0.0.0 through 239.255.255.255.

Once the MPS4264s have been configured to be included in a cluster and a connection has been established with the “master” unit - issue the command:

MFIND

A list of MPS modules included in the cluster will be returned. Review the list to ensure it is inclusive of all units that are expected to be included in the cluster. Once this has been verified, a scan on all units can be initiated with the command:

MSCAN

If at any point the scan needs to be terminated, issue the command:

MSTOP

These “multiple unit” commands that allow control of the cluster of scanners.

MULTIPLE UNIT SCAN COMMAND

Multiple MPS units are started scanning by connecting to one MPS and issuing a **MSCAN** command. This device becomes the master and reissues a multicast SCAN command. See the table below for the scan start packet format. All devices that are set up to listen to this multicast address will respond to the SCAN command. The slave devices must still fulfill the SSD and SST requirements for starting a scan.

TABLE 3-1: MSCAN PACKET FORMAT

FUNCTION	BYTES	DATA TYPE	DESCRIPTION
Packet Type	2	Integer	0202

Further information on the MSCAN command can be found in “Multiple Unit Scan” on page 65.

MULTIPLE UNIT STOP COMMAND

Multiple MPS units are stopped scanning by connecting to one MPS and issuing a **MSTOP** command. This device becomes the master and reissues a multicast STOP command. See the table below for the stop packet format. All devices that are set up to listen to this multicast address will respond to the STOP command.

TABLE 3-2: MSTOP PACKET FORMAT

FUNCTION	BYTES	DATA TYPE	DESCRIPTION
Packet Type	2	Integer	0303

Further information on the MSTOP command can be found in “Multiple Unit Stop” on page 65.

MULTIPLE UNIT FIND COMMAND

The user may connect to one MPS4000 and issuing a **MFIND** command. This command will return a list of all devices that are part of the multicast cluster. The MFIND command used the Discovery Packet described below.

TABLE 3-3: MFIND PACKET FORMAT

FUNCTION	BYTES	DATA TYPE	DESCRIPTION
Packet Type	2	Integer	0101

Further information on the MFIND command can be found in “Multiple Unit Find” on page 65.

SCANNING WITH AN EXTERNAL TRIGGER

The MPS4264 can be configured to scan with an external hardware or software trigger. This provides a simple means of synchronizing the data collection between multiple MPS scanners when an IEEE-1588 architecture is not in place. It also provides a means of synchronizing MPS scanners with other equipment that may not be IEEE-1588 compatible. The MPS4264 has several options for external triggering. The external trigger can be use in one of three ways:

1. Hardware Frame Trigger
2. Hardware Scan Trigger
3. Software Frame Trigger

Options 1 & 3: the “frame trigger” options allow an external trigger to release a single frame of data. This means for a single trigger pulse (or command) the MPS will return a single frame of averaged data.

Option 2: the “Hardware Scan Trigger” option means that a if the trigger input level is “high” (5Vdc<voltage<15Vdc) the MPS will enter scan mode where it will scan and continuously collect data based on its internal clock. The MPS will continue to scan at this rate until any of the following conditions are met:

- The trigger input level is switched to “low” (<5Vdc)
- FPS term is met
- The scan is manually stopped with the STOP command

The external hardware trigger voltage is input through pins 4 & 5 of the power connector. The trigger is 5-15Vdc, 6.5mA. A wiring diagram for the power/serial/trigger cable can be found in “Serial Communications” on page 16. The external software trigger is a command sent to the MPS. The trigger can be one of two commands, either a TRIG command or a <tab>. More information on the TRIG variable can be found in “Set Trigger (TRIG)” on page 49. Information on the software trigger can be found in “Software Frame Trigger” on page 53.

SETTING UP AN EXTERNAL FRAME TRIGGER

To configure the MPS4264 to scan with an external frame trigger:

1. Set the variable “TRIG” to 1
2. Set the “RATE” variable to a rate that is approximately 25% faster than the intended trigger rate
3. Set the MPS into “scan” mode by sending the command: SCAN
4. Supply a trigger, either hardware trigger pulse or a software trigger. For each trigger pulse, the MPS will return a single frame of data

SETTING UP AN EXTERNAL SCAN TRIGGER

To configure the MPS4264 to scan with an external scan trigger:

1. Set the variable “TRIG” to 2
2. Set the “RATE” variable to the desired data collection rate
3. Supply a “high” voltage (5Vdc<voltage<15Vdc). The MPS will collect data at the defined rate until the trigger input voltage is lowered below the 5Vdc trigger level.

AUTO SCAN OPTION

When TRIG is set to 3, the Auto Scan feature is enabled. This commands the MPS4000 to start scanning after the power up sequence has completed. This feature only supports data output via UDP or FTP. The type of scan data output to the FTP server is set according to the format settings (CSV, ASCII or Binary). The type of scan data output via UDP can only be Binary.

If FTP output is configured for Auto Scan: when the FTP server is not ready to handle a connection from the MPS4264, the MPS will continue to attempt to connect until it succeeds, a STOP command is received from the serial interface or a STOP is received from the network interface. Stopping the auto scan by connecting with Telnet and issuing a STOP command is the preferred method used to change the TRIG setting from 3 when other trigger options are desired.

Once scanning is started, it continues until a STOP is received, as described above. Simply shutting off the MPS will stop the sending of data. In the case of FTP output; normally this will cause the FTP server to begin a time out period waiting for data. After the time out period, the FTP server should close the connection, flush any unsaved data to disk and close the file. The time out period of the FTP server is usually configurable. FTP servers may vary in their operation so check your FTP server manual for settings.

FAST SCAN OPTION (850Hz - 2500Hz)

Fast scan allows the MPS4264 to scan a reduced number of channels at a faster rate than is possible with all 64 channels. The set of reduced channels for a fast scan is 16 channels.

Not just any channel can be placed in the 16 channel fast scan group. Fast scan mode reduces the channel count down to one channel per A/D converter. Because of the association between channel numbers and A/Ds, the 16 channel fast scan group must contain 16 channels and start with channel 1, 2, 3 or 4. The channels that are part of each 16 channel fast scan group are shown in the table below.

To enable “Fast Scan” mode, the first term of the OPTIONS

variable is set to the desired starting channel number. The setting of the first term of the OPTIONS variable will correspond to the channel list in Table 3-4 below. The fast scan setting of 1, 2, 3 or 4 applies to the binary (B) and CSV (C) format settings. An error is produced if used with non B and C settings. An error is also produced if the “starting channel” is not 1, 2, 3 or 4. Format C is only useful for checkout and setup because the fast rate can not be maintained with Format C. Format B is the only setting that can maintain fast rates. The channels that are not part of the selected fast scan group have invalid data. External frame trigger can be used for fast scan. Starting a fast scan from the Web Browser is not supported.

More information on the OPTIONS variable can be found in “Set Options (OPTIONS)” on page 60. The data packet for fast scan data is defined in “Table 5-7: Fast Scan Binary Data Format” on page 40.

TABLE 3-4: FAST SCAN CHANNEL GROUPS

STARTING CHANNEL	NUMBER OF CHANNELS	CHANNELS IN SCAN
1	16	1,5,9,13,17,21,25,29,36,40,44,48,52,56,60,64
2	16	2,6,10,14,18,22,26,30,35,39,43,47,51,55,59,63
3	16	3,7,11,15,19,23,27,31,34,38,42,46,50,54,58,62
4	16	4,8,12,16,20,24,28,32,33,37,41,45,49,53,57,61
0	64	All channels, 1-64

With “Fast Scan” enabled, the RATE variable is used to determine the data output rate of the limited group of channels. Data can be scanned on 1/4 of the channels at up to 2500Hz.

[INTENTIONALLY LEFT BLANK]

SECTION 4: HARDWARE

PNEUMATIC CONNECTIONS

The MPS modules has several different pneumatic connections. All pneumatic inputs are located on the top of the module. There are two basic groups of pneumatic connections types on the module: pressure measurement connection and configuration/support connections. All pneumatic inputs are through one of three removable headers for easy plumbing and system re-configuration. The measurement ports are located on the on the outer edge of the modules and are identified as 1-32 on one pneumatic header and 33-64 on the opposite pneumatic header. These 64 input ports are directly connected to one of the individual pressure transducers within the module. One the same pneumatic headers as the measurement input ports are the purge input ports. Each purge input port is used as the purge supply feed for purging the input lines on the respective side of the module.

The remaining configuration/support type pressure inputs are all located on the center removable header. They are: CAL CTL, REF, CAL and Px CTL. These ports are used for applying known pressures during calibration, cycling the internal valve between states and connecting the reference manifold to a known, stable ambient pressure.

The 64 measurement input ports (or Px ports) are available with 0.042" or 0.031" OD tubes. The remaining tubes for the PRG, CAL, REF and CTL inputs will always be 0.063" OD.

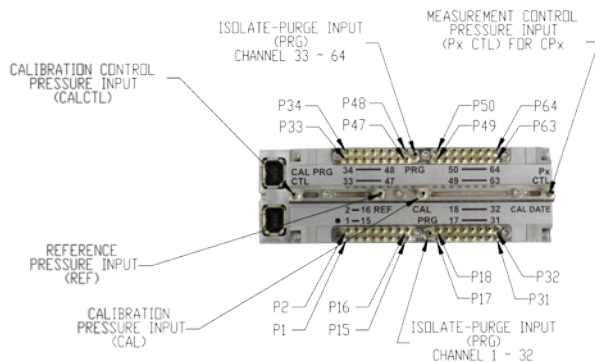

FIGURE 4-1: PNEUMATIC INPUTS, CPX VARIANT

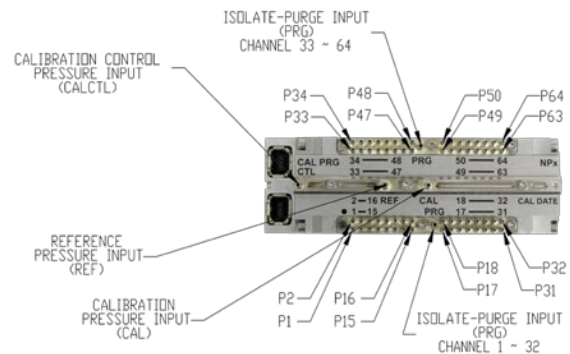

FIGURE 4-2: PNEUMATIC INPUTS, NPX VARIANT

BASICS OF CONNECTING INPUT TUBES

All pneumatic connections are 0.063", 0.042" or 0.031" OD stainless steel bulged tubulations. These tubes are designed to have a tight-fitting plastic tube slid over the OD of the tube. For all low pressure connections (50psi and less) the plastic tubing can simply be slid over the tubulation and the connection is complete. When using Urethane or Vinyl tubing for high pressure applications, a helical spring clamp over the OD of the plastic tubing is recommended. The clamp is slid over the tubing and located around the apex of the bulged of the tubulation. This helps hold the plastic tubing in place and prevent leaks.

Installing the plastic tubing over the stainless steel tubing can be done much easier by using Scanivalve's special "Tubing push-on tool" P/N: TPOTL-XXX. This tool is offered in a variety of sizes to work for tubing from 0.031" to 0.125" OD.

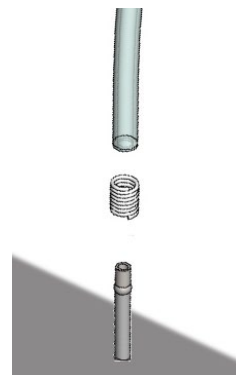

FIGURE 4-3: TUBULATION CONNECTION WITH HELICAL SPRING CLAMP

PRESSURE MEASUREMENT (Px) PORTS

Each MPS4264 scanner module has 64 pressure measurement ports, or “Px” ports. They are labeled as 1-64. Each of these ports are connected to a discrete pressure transducer. If any Px ports are not being used, it is recommended that they be plugged to prevent dust or any debris from clogging the port or contaminating the internal calibration valve.

CALIBRATION (CAL) PORT

The MPS module has a single “CAL” port in the center of the middle input header. The “CAL” port provides a means of applying a known calibration pressure to a single port and have it manifolded to the positive side of all of the transducers. During normal operations when the module is in measurement mode this port is internally blocked off. Any pressure applied to the “CAL” port will not reach the transducers unless the internal calibration valve has been configured to direct the calibration pressure to the transducers. For most low pressure applications (below 15psi) where accuracy is important, the “CAL” port should be connected to a known, stable static location when not being used to apply calibration pressures. This ensures that when a pneumatic zero offset calibration (CALZ) is performed no unwanted offsets are introduced.

REFERENCE (REF) PORT

The ‘REF’ port ties into a manifold that connects the back side (or negative side) or all transducers together. During most applications, the ‘REF’ port of low pressure modules (below 15 psi) should be routed to a known, stable static location. Typically this “reference” location will be a wind tunnel static port, a static barrel or in flight test applications the aircraft static system. This ensures that when a zero offset calibration (CALZ) is performed no unwanted offsets are introduced. During a calibration, positive pressures will be applied through the ‘REF’ port to perform the negative portion of the calibration.

For applications where an elevated reference pressure will be used, the maximum pressure applied to the REF input is 50psi.

PURGE (PRG) PORTS

The purge supply (PRG) port is the input for the pressure that will be used to purge the pressure measurement (Px) lines. ***The supplied purge pressure can be up to 75psi, and must always be clean, dry instrument grade air or nitrogen.*** In order for the purge supply pressure to successfully feed to and clear the Px input lines, the MPS must be in Calibration/Purge mode. This is done by applying control pressure to the “CAL-PRG CTL” port.

Recommended purge pressures are based off of the module’s pressure range and are as follows:

Module Pressure Range	Recommend Purge Pressure
4” H ₂ O	1.5 PSI
8” H ₂ O	3.0 PSI
1 PSI	10 PSI
5 PSI	25 PSI
15+ PSI	75 PSI

CALIBRATE MODE CONTROL (CAL-PRG CTL) PORT

The “CAL-PRG” control pressure input is used to shift the internal calibration valves into Calibration/Purge mode. In this mode, the positive side of all transducers are tied together and connected to the CAL input, and the individual Px input tubes are manifolded together internally and connected to the purge supply (“PRG”) ports. ***The maximum input pressure for the CAL-PRG CTL input is 120psi.*** Clean, dry instrument grade air or nitrogen should be used.

For modules that are configured with the “NPx” actuation, 90-120psi is recommended to cycle the valve completely and reliably.

For modules that are configured with the “CPx” actuation option, the required control pressure to cycle the valve is 60-70psi. Often this can be done with less pressure, but 60psi is recommended for reliable operation of the valve. For “CPx” modules, in normal, low-vibration environments the control pressure does not need to be continuously supplied to this port to hold the valve in the Calibrate mode. Applying the pressure for 2-4 seconds will cycle the valve into the calibrate mode where it will stay until cycled out using the Px CTL port. For high vibration environments, or where it is absolutely critical that the module be held in calibrate mode, it is recommended to continuously supply the pressure to this port to hold the valve in the desired state.

This port will not be available with the “EPx” configuration.

MEASUREMENT MODE CONTROL (Px CTL) PORT

The “Px CTL” control pressure input is used to shift the internal calibration valve into the “Measurement” mode. In this mode, each of the individual transducers are tied to the discrete input (Px) tubes. The CAL and PRG input ports are blocked off. This input port is only present on modules configured with the “CPx” actuation option. ***The maximum input pressure for the Px CTL input is 70psi.*** To actuate or cycle the valve 60-70psi is recommended. Often this can be done with less pressure, but 60psi is recommended for reliable operation of the valve. Clean, dry instrument grade

air or nitrogen should be used.

In normal, low-vibration environments the control pressure does not need to be continuously supplied to this port to hold the valve in the measurement mode. Applying the pressure for 2-4 seconds will cycle the valve into the measurement mode where it will stay until cycled out using the Px CTL port. For high vibration environments, or where it is absolutely critical that the module be held in measurement mode, it is recommended to continuously supply the pressure to this port to hold the valve in the desired state.

This port is not available with a “NPx” or “EPx” configuration.

REMOVABLE PRESSURE INPUT HEADERS

All pneumatic inputs to the MPS are through three removable input headers. Each of the three headers is held in place with three #1-72 screws. A 1/16” Allen/hex wrench fits the screws.

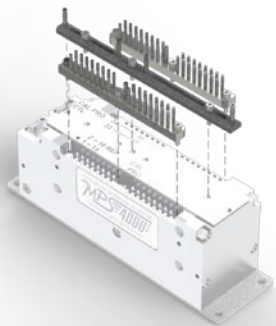

FIGURE 4-4: REMOVABLE INPUT HEADERS

The center header is polarized and cannot be installed backwards. However, the two Px input headers are interchangeable and can be installed on the opposite sides. To keep the manifolds unique and identified, the header for inputs 1 through 32 has a single black oxide screw, whereas all of the rest are nickel plated and silver in color. The “correct” location for the black oxide screw is identified on the MPS with a solid black dot. See Figure 4-5 below:

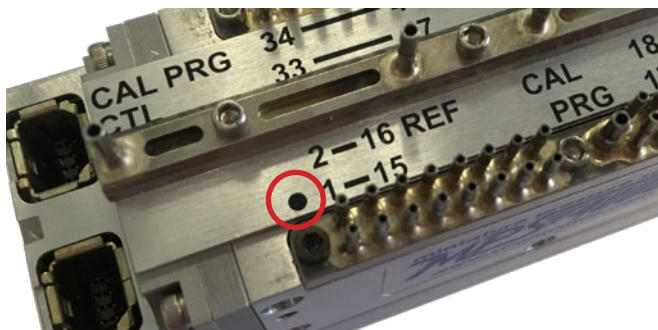

FIGURE 4-5: HEADER IDENTIFIER MARK

Be aware, that when the center header is removed the identification plate will no longer be held in place. Like the center header it is indexed and cannot be installed backwards, but should be handled with care. The O-rings supported in the identification plate should be kept clean and watched to make sure they stay in place. Replacement or additional headers can be purchased separately as needed.

CALIBRATION VALVE

The MPS4264 module has two mirrored calibration valves, each servicing 32 inputs. It is a slider-style valve with the aluminum shuttle riding on ball bearings.

The calibration valve has two physical states, “Measurement” and “Calibrate/Purge.” In measurement mode, measurement pressures from the individual input tubes is allowed to pass directly through the shuttle valve to the pressure sensors. In calibrate/purge mode, the measurement pressures from the individual input tubes are blocked off and isolated from the pressure sensors. Instead, the “CAL” input is manifolded and connected to the positive side of all transducers. Additionally, the two “Purge” input lines are connected to the input tubes on their respective valves allowing the user to clear debris or moisture from the input lines by blowing from the module back out to the test article.



CAUTION! Do not cycle the valve with pressure supplied to either the CAL or PRG inputs.

It is uncommon, but possible, that while the valve is switching states (between measurement and calibration/purge modes) that any pressure applied to the “CAL” or the “PURGE” ports could “sneeze” past the sealing O-rings and reach the pressure sensor. To prevent risking potential damage to the sensors, the valve should always be cycled with no “CAL” or “PRG” pressure supplied.

Also note that when the valve is in the calibrate/purge state, all 32 measurement inputs on each valve are tied together and connected to the “PRG” input. For most applications this is not a problem, but it will allow “mixing” of measurement pressures between channels. In cases where humid or dirty air is being measured, this “mixing” would provide a flow path in a higher pressure input and back out of a lower pressure input, carrying moisture or

debris with it. If it is the case where the module will be help in calibrate/purge mode for an extended period of time while still connected to dirty or humid measurement pressures, a purge pressure great enough to prevent flow from the test article to the scanner should be supplied. For most applications however, this is not needed.

ELECTRICAL CONNECTORS

The MPS4264 has two electrical connectors located adjacent to each other on one end of the module. Both connectors are TE Connectivity “Mini I/O” series and are polarized to prevent improper connections. The connectors are latching to ensure a reliable connection. To disconnect the connectors, press down on the latch (shown in Figure 4-6 below) and pull up on the connector.

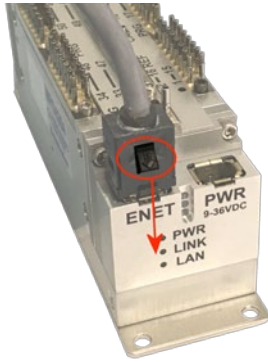

FIGURE 4-6: POWER/ETHERNET CONNECTOR LATCH

POWER CONNECTOR & POWER REQUIREMENTS

The power connector serves three purposes. Primarily, it is the power connector, bringing in the 9-36Vdc required to power the MPS. Additionally, it serves as the external trigger input (pins 4 & 5) as well as the serial communications connection (pins 1-3). See “Appendix F - Cable Drawings and Pinouts” on page 92 for cable drawings and pinout.

The MPS accepts 9-36Vdc and has a maximum power consumption of 3.5W. The EPx configuration requires 18-36Vdc with a maximum consumption of 5.5W during valve transition.



CAUTION

CAUTION! Do not make or break the power connector with power applied! Doing so risks damage to the module!

ETHERNET CONNECTOR

The Ethernet connection is the primary means of

communications with the MPS4264. The connection does support MDIX Auto-Crossing. See “Appendix F - Cable Drawings and Pinouts” on page 92 for cable drawings and pinout.

MPSTCU - THERMAL CONTROL UNIT

The MPS (Miniature Pressure Scanner) line of Thermal Control Units is available for applications where temperature changes may be great enough to exceed the temperature compensated range of the scanner. Exceeding the compensated temperature range can induce errors in the pressure measurements. See “Section 1: Specifications” on page 7, for more information on the compensated temperature range.

MPSTCU applications include flight test, automotive, wind turbine, wind tunnel, and engine tests. When used in a flight test environment, it is recommended that the TCU case be vented.

Each MPSTCU includes a rugged IP-54 rated aluminum enclosure, pneumatic connectors, and a power/data connection. The MPSTCU offers an optional heater circuit which can provide a controlled temperature environment while the MPSTCU is subject to a cold environment (up to -60°C). Additionally, the MPSTCU also offers an optional cooling port to provide cooling air when the MPSTCU is subject to temperatures from 60-120°C. When the Cooling Kit is used, 3.0CFM of 23°C air is required while operating the MPSTCU in a 125°C environment.

For wiring diagrams of MPSTCU cabling, see “MPS4264TCU Cable” on page 92.

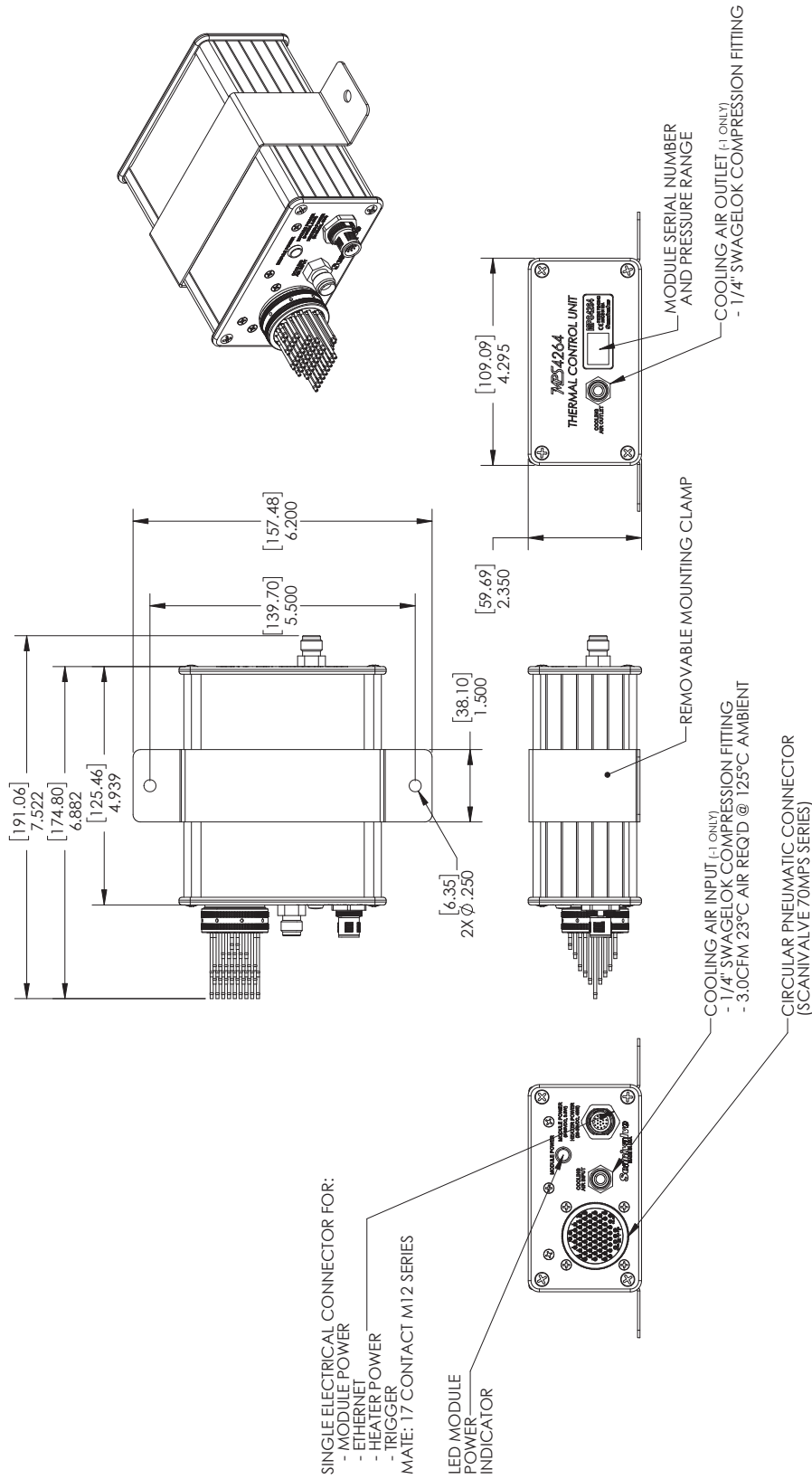

MPS4264TCU OVERVIEW DRAWING

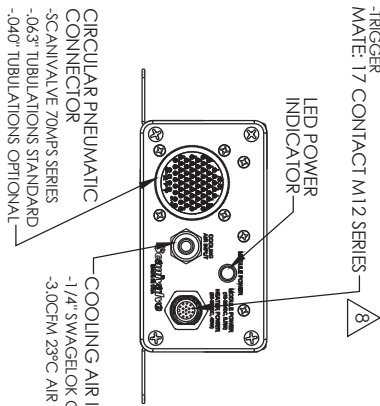

SINGLE ELECTRICAL CONNECTOR FOR:

- MODULE POWER
- ETHERNET
- HEATER POWER (-1,-2 ONLY)
- TRIGGER
- MATE: 17 CONTACT M12 SERIES

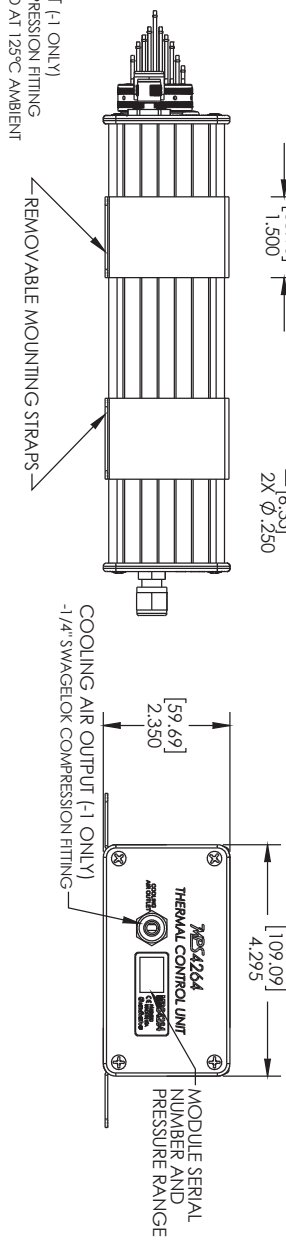
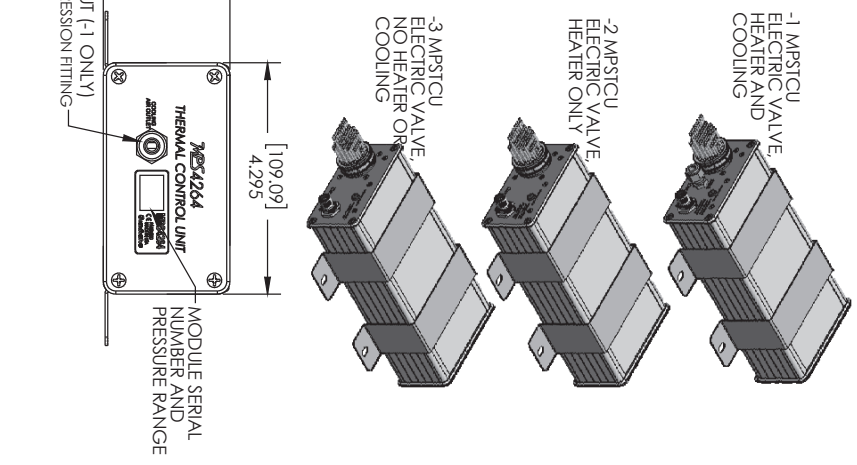
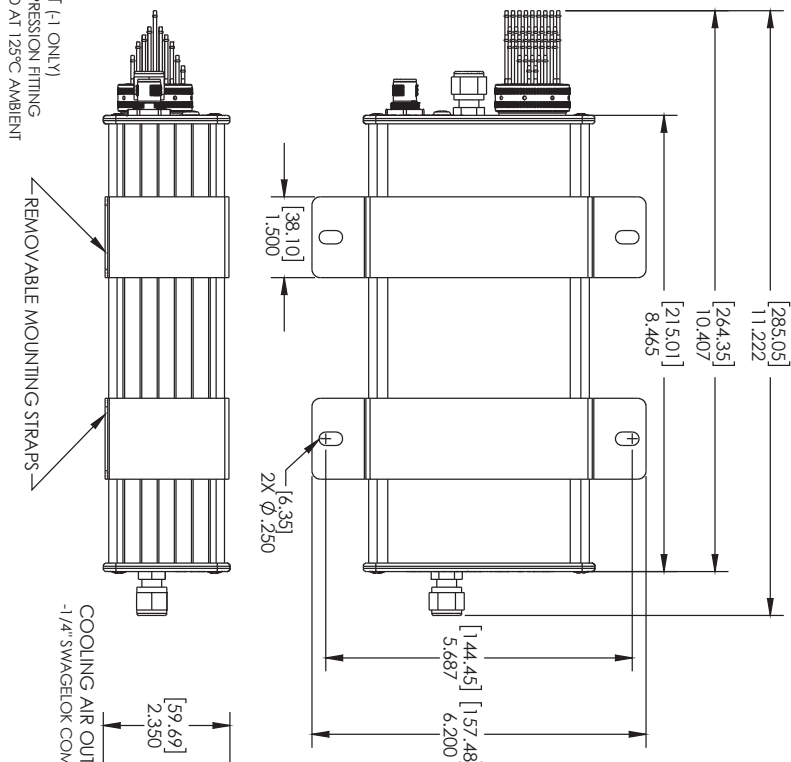

MPS4264TCU/EPX OVERVIEW DRAWING

[INTENTIONALLY LEFT BLANK]

SECTION 5: SOFTWARE

OVERVIEW

The MPS4264 is essentially a single user network server that supports connections from a Telnet Client, Web Browser Client, Binary Client, FTP Client (for data transfers) and FTP Server (for file transfers). The MPS4264 supports serial communication that is solely used to set a limited group of configuration variables for diagnostics or when the IP address is not known. The MPS4264 also supports a limited number of commands from a multicast master. It also acts as a multicast master. This design allows a single MPS4264 to reissue commands to multiple MPS4264s acting as slaves.

COMMAND FORMAT

Each of the commands are explained with the following sections: command, syntax, arguments, description, and returns.

COMMAND lists the name of the command.

SYNTAX lists the format of the command. The following conventions are used:

BP - Boldface letters indicate command keywords and operators. Within the discussion of syntax, bold type indicates that the text must be entered exactly as shown.

<parameter> - Words in <> indicate place holders for parameters you must supply.

[parameter] - Words in [] indicate place holders for optional parameters that you are not required to supply.

data - Example data is shown in *italics*.

data - Example commands are show in **bold**.

, - Commas separate options, only one of the options may be used.

<CR> - The carriage-return key, sometimes marked as a bent arrow, Enter, or Return on the key board, is called <CR>.

Spaces, as used in the syntax, are entered as spaces.

DESCRIPTION describes the function of the command.

RETURNS lists the format of the information that the unit returns to the host.

A PROMPT (>) will be output when the MPS4264 is ready to accept a command.

TCP/IP does not guarantee that packet boundaries will be maintained between a Host and a MPS4264. Therefore, ALL commands from a Host MUST be terminated properly. The two options are:

CR-LF (ASCII 13 - ASCII 10) or CR (ASCII 13)

The maximum string length for commands send to the MPS4264 is 79 characters. Any command received that is longer than 79 characters will be discarded and an error will be generated.

When a communications variable is modified (those in the LIST IP group), the MPS4264 program must be restarted, preferably with the REBOOT command, in order for the changes to take effect.

OUTPUT SCAN DATA FORMATTING AND ROUTING

The MPS4000 supports four data destinations. They are: FTP Server, Telnet Client, Web Browser Client, and Binary Client. The data destination is based on the connections, configurations, and source of command. The following table describes the output data routing based on the factors defined in "Table 5-1: Data Destinations" on page 36.

TABLE 5-1: DATA DESTINATIONS

CONFIGURATION							DESTINATION	SUPPORTED FORMATS									
1	X	X	X	X	X	Ignored	WB	•	•								
0	1	1	X	X	X	Ack	Bin					•					
0	1	0	X		X	Ack	Bin										
0		1	0	0	0	Ack	TN	•	•	•							
0		1	1	0	0	Ack	FTP & UDP	•	•								
0		1	1	1	1	Ack	UDP										
0		0	0	0	1	Ack	UDP					•					
0		0	1	1	0	Ack	FTP & UDP	•	•								
0		0	1	1	1	Ack	UDP	•	•								
0		0	0	0	1	Ack	UDP										

Notes:

Any new connection that occurs while scanning will cause scanning to stop.

Blank cells indicate "Not Possible"

Bin Con and Multi Server are multiplexed and cannot both be active at the same time.

When the web browser is connected all commands are ignored from serial and Telnet with an error message

WB – Web Browser, Bin – Binary Server, TN – Telnet, FTP – File Transfer Protocol Server

ASCII DATA FORMATS

Scan data from the MPS4000 can be formatted in six different ways: ASCII (A), Comma Separated Variable (CSV or C), formatted for VT100 terminals (F), Binary (B) LabVIEW Binary (L) and Statistical Binary (S). The format is selected by setting the FORMAT configuration variable to A, C, F, B, L, or S respectively. It can also be selected by clicking on the appropriate link on the “Scan” page when using the Web Browser.

The FORMAT configuration variable sets the format for Telnet (T), FTP (F), and Binary Server (B) separately. See the description of FORMAT for detailed description.

Data output in ASCII, CSV, and FORMATTED are typically used for low speed data transfers, less than 10 Hz. Binary data output is used for high speed data transfer up to 850 Hz. Appendix A shows the binary packet format and Appendix B shows the statistical binary packet format.

BASIC ASCII DATA OUTPUT

“Table 5-2: ASCII Data Output” shows an example of ASCII data output (SET FORMAT T A):

TABLE 5-2: ASCII DATA OUTPUT

1 1 0.0021 30.44
1 2 -0.0009 29.88
1 3 -0.0010 30.31
1 4 -0.0015 30.13
1 5 0.0020 30.31
1 6 -0.0004 30.06
1 7 0.0006 29.94
1 8 -0.0012 30.19
1 9 0.0023
1 10 0.0006
1 11 -0.0009
.....
1 59 -0.0004
1 60 0.0021
1 61 -0.0005
1 62 -0.0007
1 63 -0.0003
1 64 0.0021
<p>Notes: Configuration selected with by setting the “FORMAT” variable to “A”. Column 1 is the frame number Column 2 is the channel number Column 3 is the pressure in either engineering units or raw counts. Column 4 for the first 8 rows is the temperature of the 8 temperature sensors in degrees C</p>

FORMATTED ASCII DATA OUTPUT

“Table 5-3: Formatted ASCII Data Output” shows an example of ASCII data output formatted for a VT100 Terminal (SET FORMAT T F):

TABLE 5-3: FORMATTED ASCII DATA OUTPUT

<pre> Frame= 1 T1= 35.1 C T2= 34.7 C T3= 35.1 C T4= 34.9 C T5= 35.1 C T6= 34.8 C T7= 34.7 C T8= 34.9 C 01= 0.0028 02= -0.0016 03= -0.0011 04= -0.0014 05= 0.0020 06= -0.0003 07= -0.0003 08= -0.0014 09= 0.0017 10= 0.0011 11= -0.0002 12= -0.0009 13= 0.0032 14= 0.0015 15= 0.0028 16= -0.0005 17= 0.0018 18= 0.0022 19= -0.0006 20= -0.0019 21= -0.0000 22= -0.0007 23= -0.0018 24= -0.0022 25= 0.0029 26= 0.0001 27= 0.0000 28= -0.0006 29= -0.0000 30= 0.0010 31= 0.0004 32= -0.0007 33= -0.0005 34= -0.0018 35= 0.0008 36= 0.0011 37= 0.0003 38= -0.0001 39= -0.0001 40= 0.0029 41= -0.0005 42= -0.0016 43= -0.0003 44= 0.0019 45= 0.0003 46= -0.0002 47= 0.0001 48= 0.0021 49= -0.0002 50= 0.0003 51= 0.0004 52= 0.0016 53= 0.0014 54= 0.0002 55= 0.0009 56= 0.0007 57= -0.0006 58= -0.0010 59= -0.0009 60= 0.0024 61= -0.0008 62= -0.0006 63= 0.0002 64= 0.0026 </pre>
<p>Notes: Configuration selected with by setting the “FORMAT” variable to “F”. This format should only be selected for displaying data on a screen. The 8 temperatures are shown as T1 through T8. The 64 pressures are shown as 01 through 64 This format uses VT-100 control codes to set cursor positions for column alignment.</p>

ASCII CSV DATA OUTPUT

“Table 5-4: CSV Data Output” shows an example of Comma Separated Variable data formatted (SET FORMAT T C):

TABLE 5-4: CSV DATA OUTPUT

<pre> Frame,Seconds,Tx1,Tx2,Tx3,Tx4,Tx5,Tx6,Tx7,Tx8,Px1,Px2,Px3,Px64 1,0.100,40.38,39.88,40.38,40.13,40.31,40.00,39.88,40.13,0.0030,-0.0011,-0.0010,-0.0025 2,0.200,41.50,41.00,41.50,41.25,41.44,41.13,41.00,41.25,0.0022,-0.0013,-0.0014,-0.0024 3,0.300,41.50,41.00,41.50,41.19,41.44,41.13,41.00,41.25,0.0017,-0.0017,-0.0006,-0.0030 4,0.400,41.50,41.00,41.50,41.19,41.44,41.13,41.00,41.25,0.0013,-0.0018,-0.0005,-0.0026 5,0.500,41.50,41.00,41.50,41.19,41.44,41.13,41.00,41.25,0.0021,-0.0013,-0.0005,-0.0028 6,0.600,41.50,41.00,41.50,41.19,41.44,41.13,41.06,41.25,0.0025,-0.0015,-0.0009,-0.0031 7,0.700,41.50,41.00,41.50,41.19,41.44,41.13,41.06,41.25,0.0027,-0.0011,-0.0015,-0.0026 8,0.800,41.56,41.00,41.50,41.19,41.44,41.13,41.06,41.25,0.0026,-0.0004,-0.0015,-0.0025 </pre>
<p>Notes: Configuration selected with by setting the “FORMAT” variable to “C”. The output shown omits channels 4 through 63 for simplicity Each column is separated by a comma and each row is delimited by a CR LF This format is easily imported to Excel or Open Office spread sheets.</p>

BINARY DATA FORMATS

Binary data formats follow network byte order (big endian).

BINARY DATA FORMAT**TABLE 5-5: BINARY DATA FORMAT**

FUNCTION	BYTES	DATA TYPE	DESCRIPTION
Packet Type	4	Integer	A Hex
Packet Size	4	Integer	Size in bytes of this packet (348)
Frame Number	4	Integer	The current frame number if in the scan mode
Serial Number	4	Integer	Set by SN in LIST ID
Frame Rate	4	Float	Scanning rate in Hz
Valve Status	4	Integer	0-Px, 1-Cal
Units index	4	Integer	Units conversion index (see Appendix E - Binary Index)
Units conversion factor	4	Float	Conversion factor from PSI to selected units
PTP Scan Start Time (sec)	4	U Integer	Scan start time in seconds
PTP Scan Start Time (ns)	4	U Integer	Scan start time in nanoseconds
External Trigger Time	4	U Integer	External Trigger Time in us
Temperatures (8 temperatures)	32	Float	Array of 8 temperature values as read from the 8 temperature chips.
Pressures	256	Float or Integer	Array of 64 pressure values. Float if EU is selected, Integer is RAW is selected. The float or integer is selected based on the units.
Frame Time	4	U Integer	Time the frame occurred (seconds)
Frame Time	4	U Integer	Time the frame occurred (nanoseconds)
External Trigger Time	4	U Integer	Time the external trigger occurred (seconds)
External Trigger Time	4	U Integer	Time the external trigger occurred (nanoseconds)

FAST SCAN BINARY DATA FORMAT**TABLE 5-6: FAST SCAN BINARY DATA FORMAT**

FUNCTION	BYTES	DATA TYPE	DESCRIPTION
Packet Type	4	Integer	10Hex
Packet Size	4	Integer	Size in bytes of this packet (348)
Frame Number	4	Integer	The current frame number if in the scan mode
Serial Number	4	Integer	Set by SN in LIST ID
Frame Rate	4	Float	Scanning rate in Hz
Valve Status	4	Integer	0-Px, 1-Cal
Units index	4	Integer	Units conversion index (see Appendix E - Binary Index)
Units conversion factor	4	Float	Conversion factor from PSI to selected units
PTP Scan Start Time (sec)	4	U Integer	Scan start time in seconds
PTP Scan Start Time (ns)	4	U Integer	Scan start time in nanoseconds
External Trigger Time	4	U Integer	External Trigger Time in us
Temperatures (8 temperatures)	32	Float	Array of 8 temperature values as read from the 8 temperature chips.
Pressures	256	Float or Integer	Array of 64 pressure values. Float if EU is selected, Integer is RAW is selected. The float or integer is selected based on the units. When fast scan is enabled only 16 of the 64 channels are valid.
Frame Time	4	U Integer	Time the frame occurred (seconds)
Frame Time	4	U Integer	Time the frame occurred (nanoseconds)
External Trigger Time	4	U Integer	Time the external trigger occurred (seconds)
External Trigger Time	4	U Integer	Time the external trigger occurred (nanoseconds)

FILE NAMES AND FORMATS

The MPS4264 can be configured to output a variety of different files types and configurations. “Table 5-8: File Name Extensions” below shows the file name extensions used based on the setting of the FORMAT variable.

TABLE 5-7: FILE NAME EXTENSIONS

SETTING OF FORMAT VARIABLE	TYPE OF SCAN	FILE EXTENSION
SET FORMAT F A	ASCII	nnnn.txt
SET FORMAT F B	Binary	nnnn.dat
SET FORMAT F C	Comma Separated Variable	nnnn.csv
SET FORMAT F S	Statistical Scan	nnnn.dat

GENERAL CONTROL COMMANDS**VERSION**

DESCRIPTION	Shows the current software version.
SYNTAX	VER
RETURNS	The version followed by the prompt when ready for the next command
EXAMPLE	VER <i>MPS Scanivalve (c) 2016 Ver 2.05</i> >

BOOT LOADER VERSION

DESCRIPTION	Shows the current software version of the boot loader.
SYNTAX	BLVER
RETURNS	The boot loader version followed by the prompt when ready for the next command.
EXAMPLE	BLVER <i>BOOTLOADER VERSION: Ver 1.04</i> >

CALIBRATION VERSION

DESCRIPTION	Shows the software version of the MPS used during the last saved calibration.
SYNTAX	CALVER
RETURNS	The version followed by the prompt when ready for the next command
EXAMPLE	CALVER <i>2.08</i> >

FIRMWARE FILES CHECK

DESCRIPTION	Checks the current files loaded on the MPS against the index in the .TAR file. This verifies file names and creation dates.
SYNTAX	TARCHK
RETURNS	List of files and error summary
EXAMPLE	TARCHK <i>Starting TARCHK</i> <i>Testing file MPS4000.BIT</i> <i>Testing file Mps4000.hex</i> <i>Testing file calval.htm</i> <i>Testing file databar.htm</i> <i>Testing file favicon.ico</i> <i>Testing file home.gif</i> <i>Testing file home.jpg</i> <i>Testing file home.htm</i> <i>Testing file idframe.htm</i> <i>Testing file index.htm</i> <i>Testing file navframe.htm</i> <i>Testing file remote.htm</i> <i>Testing file setup.htm</i> <i>Testing file svlogo.gif</i> <i>Testing file term.htm</i> <i>Finished TARCHK with 0 errors</i>

REBOOT

DESCRIPTION	Restarts the MPS4000.
SYNTAX	REBOOT or RESTART
RETURNS	Nothing
EXAMPLE	REBOOT

FORMAT FLASH DISK

DESCRIPTION	Formats the flash memory of the MPS. WARNING: Formatting the flash memory is considered an advanced operation. Use caution before proceeding or please contact Scanivalve for information.
SYNTAX	FDISK
RETURNS	<p>>fdisk Type <i>FDISKCONFIRM</i> to confirm <i>FDISK</i> or <i>STOP</i> to escape</p> <p>>fdiskconfirm Start format Erasing device 100 Done device 100</p>
EXAMPLE	<p>>fdisk Type <i>FDISKCONFIRM</i> to confirm <i>FDISK</i> or <i>STOP</i> to escape</p> <p>>fdiskconfirm Start format Erasing device 100 Done device 100</p>

STATUS

DESCRIPTION	Displays the current mode of the MPS4000
SYNTAX	STATUS
RETURNS	<p>One of the following: READY – Ready mode SCAN – Currently scanning CAL – Performing a calibration VAL – Performing a validation CALZ – Performing a zero calibration CALM – Performing a manual calibration EVALVE - Electric valve is in transition Followed by a prompt when ready for the next command.</p>
EXAMPLE	<p>STATUS <i>STATUS: READY</i> ></p>

STOP

DESCRIPTION	Cancels all commands and returns the MPS4000 to Ready mode.
SYNTAX	STOP or <ESC>
RETURNS	Prompt ready for the next command.
EXAMPLE	<p>STOP ></p>

TAR FILE UNPACK

DESCRIPTION	Commands the MPS to unpack the designated .TAR file.
SYNTAX	TAR <filename>
RETURNS	List of files unpacked.
EXAMPLE	<p>TAR MPS105.tar</p> <p><i>Starting to de-tar files from fileMPS105.tar</i></p> <p><i>Extracting file MPS4000.BIT 340701 2016/05/18 18:29:30</i></p> <p><i>Extracting file Mps4000.hex 695026 2016/06/13 20:54:24</i></p> <p><i>Extracting file calval.htm 19639 2015/04/17 15:05:33</i></p> <p><i>Extracting file databar.htm 18158 2016/01/12 18:56:09</i></p> <p><i>Extracting file favicon.ico 1150 2014/03/14 15:19:55</i></p> <p><i>Extracting file home.gif 81414 1980/01/01 19:00:00</i></p> <p><i>Extracting file home.jpg 16814 2014/05/12 19:14:03</i></p> <p><i>Extracting file home.htm 761 2015/05/22 22:51:24</i></p> <p><i>Extracting file idframe.htm 3933 2015/06/01 17:08:13</i></p> <p><i>Extracting file index.htm 2067 2015/05/26 14:47:55</i></p> <p><i>Extracting file navframe.htm 2944 2015/05/27 18:36:18</i></p> <p><i>Extracting file remote.htm 8141 2015/04/16 19:48:57</i></p> <p><i>Extracting file setup.htm 10312 2016/03/08 16:40:52</i></p> <p><i>Extracting file svlogo.gif 2472 2015/06/01 17:03:21</i></p> <p><i>Extracting file term.htm 3101 2015/06/03 19:33:35</i></p> <p><i>Done extracting files from MPS105.tar</i></p> <p><i>Creating TAR.NDX file</i></p> <p><i>Done creating TAR.NDX file</i></p> <p>></p>
NOTES	Capitalization of the filename entered is case sensitive and must match the file name exactly.

VALVE STATE

DESCRIPTION	Displays the current position of the Pneumatic Configuration Valve.
SYNTAX	VALVESTATE
RETURNS	<p>One of the following:</p> <p>CAL – Calibration/Purge mode</p> <p>PX – PX mode</p> <p>Transition - The valve is “In Transition” (<i>specific to EPx configuration</i>)</p> <p>Followed by a prompt when ready for the next command.</p>
EXAMPLE	<p>VALVESTATE</p> <p>PX</p> <p>></p>

SOFTWARE FRAME TRIGGER

DESCRIPTION	When in scan mode and external trigger set, this causes the MPS4264 to sample and transfer a frame of data (one sample per all channels).
SYNTAX	TRIG or <TAB>
RETURNS	A frame of data
EXAMPLE	<p>TRIG</p> <p>></p>

READ CURRENT TEMPERATURE

DESCRIPTION	Returns the current temperatures.
SYNTAX	TREAD [<channel>] Where channel is a temperature channel number from 1 to 8. When omitted all temperature channels are returned.
RETURNS	Temperature
EXAMPLE	<p>TREAD <i>Temperature on sensor 1 is 38.625000</i> <i>Temperature on sensor 2 is 38.125000</i> <i>Temperature on sensor 3 is 38.625000</i> <i>Temperature on sensor 4 is 38.312500</i> <i>Temperature on sensor 5 is 38.250000</i> <i>Temperature on sensor 6 is 38.562500</i> <i>Temperature on sensor 7 is 38.375000</i> <i>Temperature on sensor 8 is 38.187500</i></p> <p>></p> <p>- OR -</p> <p>TREAD 32.687500,32.375000,32.500000,32.437500,32.687500,32.437500,32.687500,32.437500,</p> <p>></p> <p>-OR-</p> <p>TREAD 1 <i>Temperature on sensor 1 is 37.062500</i></p> <p>></p>

SCAN

DESCRIPTION	<p>Starts scanning and places the MPS4264 into SCAN mode.</p> <p>The MPS4264 uses the current PTP time as the scan start time under two conditions:</p> <ol style="list-style-type: none"> 1) When the PTP system is disabled via the SET PTPEN 0 command. 2) When the current time has not been received from the PTP server since the MPS4264 was powered up. Under this condition the MPS4264 time will start at Jan 1 1970, 0:00:00.000 hours, or epoch 0 time. This most likely will happen when there is no grandmaster on the network. <p>If the MPS was enabled and then disabled after receiving a time set from the PTP time server, the MPS will keep time from the last clock setting from the PTP server.</p> <p>When these two cases are not met, the MPS uses the start time set via the SET SST <time> and SET SSD <date> setting in the PTP group.</p> <p>When the current time is more recent than the scan start time, the MPS4264 will start scanning on the next frame interval that would be scheduled from the scan start time. See "Appendix D: 1588 Synchronized Scan Start" on page 89 for a discussion on starting scan using the PTP</p>
SYNTAX	SCAN
RETURNS	The Scan Data
EXAMPLE	<p>SCAN</p> <p>></p>
NOTES	Output is based on formatting and configured destination / protocol.

IDENTIFICATION VARIABLES

The identification settings control the serial number and the nominal pressure range of the MPS4000.

LIST IDENTIFICATION SETTINGS (LIST ID)

DESCRIPTION	Returns all of the identification settings.
SYNTAX	LIST ID
RETURNS	All settings followed by the prompt.
EXAMPLE	LIST ID SET SN 222 SET NPR 5.0000 -5.0000 5.0000 -5.0000 SET MCAST 224.0.1.2 >

SET SERIAL NUMBER (SN)

DESCRIPTION	Sets the serial number of the MPS.
SYNTAX	SET SN <sn> Where: <sn> is the serial number ranging from 0 to 32767.
RETURNS	Prompt when ready to accept a new command
EXAMPLE	SET SN 123 >
DEFAULT	100
RANGE	0 to 32767
NOTES	This value will get printed to the name of the Cal.cfg file when a SAVE C is issued. Format is: Cal_<sn>.cfg

SET NOMINAL PRESSURE RANGE (NPR)

DESCRIPTION	Sets the nominal pressure ranges for the MPS
SYNTAX	SET NPR <npr1p> <npr1n> <npr2p> <npr2n> Where: <npr1p> is the maximum nominal pressure for channels 1 to 32. <npr1n> is the minimum nominal pressure for channels 1 to 32. <npr2p> is the maximum nominal pressure for channels 33 to 64. <npr2n> is the minimum nominal pressure for channels 33 to 64.
RETURNS	Prompt when ready to accept a new command
EXAMPLE	SET NPR 15.0 -15.0 15.0 -15.0 >
DEFAULT	15.0 15.0 15.0 15.0

SET THE MULTIPLE DEVICE MULTICAST ADDRESS (MCAST)

DESCRIPTION	Sets the multicast IP address used for multiple unit calibration and validation. This address must be the same for all units to be calibrated as a group.
SYNTAX	SET MCAST <ipadd> Where: <ipadd> - Is the multicast address in the range of 224.0.0.0 to 239.255.255.255
RETURNS	Prompt when ready to accept a new command

EXAMPLE	SET MCAST 224.0.1.2 >
DEFAULT	224.1.1.11

SAVE COMMANDS**SAVE**

DESCRIPTION	Saves all or a particular configuration to flash.																		
SYNTAX	<p>SAVE [<configuration>]</p> <p>When no configuration is present, all configurations except C, T, and FC are saved. When a configuration is present, only that group of variables is saved. The following table shows the configuration that are valid and their associated files on flash:</p> <table border="1"> <tr> <td>IP</td> <td>ip.cfg</td> </tr> <tr> <td>ID</td> <td>id.cfg</td> </tr> <tr> <td>S</td> <td>scan.cfg</td> </tr> <tr> <td>PTP</td> <td>ptp.cfg</td> </tr> <tr> <td>FC</td> <td>Fc.cfg</td> </tr> <tr> <td>C or T</td> <td>Cal_<sn>.cfg</td> </tr> <tr> <td>M</td> <td>hw.cfg</td> </tr> <tr> <td>FTP</td> <td>ftp.cfg</td> </tr> <tr> <td>O</td> <td>oven.cfg</td> </tr> </table>	IP	ip.cfg	ID	id.cfg	S	scan.cfg	PTP	ptp.cfg	FC	Fc.cfg	C or T	Cal_<sn>.cfg	M	hw.cfg	FTP	ftp.cfg	O	oven.cfg
IP	ip.cfg																		
ID	id.cfg																		
S	scan.cfg																		
PTP	ptp.cfg																		
FC	Fc.cfg																		
C or T	Cal_<sn>.cfg																		
M	hw.cfg																		
FTP	ftp.cfg																		
O	oven.cfg																		
RETURNS	Prompt when saving is complete and ready for the next command.																		
EXAMPLE	To save all of the settings to all of the files (excluding C, T, and FC): SAVE >																		
EXAMPLE	To save only the “IP” settings to the file ip.cfg: SAVE IP – Save only the IP settings to the file ip.cfg >																		
NOTES	The “SAVE C” option saves all of the calibration coefficients along with the settings of the LIST C variable and will print the SN in the Cal.cfg file generated. As such, it can take up to 1 minute to complete.																		
WARNING	Do not power cycle a module while the module is in SAVE mode. This can cause undesirable effects. If a SAVE has been issued, wait for the MPS to return a prompt, or use the STATUS command and wait for STATUS: READY before power cycling the unit.																		

SCAN VARIABLES**LIST SCAN SETTINGS (LIST S)**

DESCRIPTION	Returns all of the scan settings
SYNTAX	LIST S
RETURNS	All of the scan setting followed by the prompt.
EXAMPLE	LIST S <i>SET RATE 5.0000</i> <i>SET FPS 0</i> <i>SET UNITS PSI 1.000000</i> <i>SET FORMAT T F,F B,B B</i> <i>SET TRIG 0</i> <i>SET ENFTP 0</i> <i>SET OPTIONS 0 0 16</i> >

SET RATE (RATE)

DESCRIPTION	Set the scan rate and data output rate in samples/channel/second (Hz)
SYNTAX	SET RATE <rate> [<outputRate>] Where <rate> is the number of samples per seconds for all 64 channels in Hz. When the optional <outputRate> is entered, the channels are sampled using the <rate> value and non-rolling average values are output at the outputRate setting. The rate and outputRate variables MUST be set such that they are related by the following equation: $\mathbf{outputRate \times nAvg = rate}$ Where nAvg is an integer in the range of 1:256, indicating the number of samples averaged per output frame. If values for rate and outputRate are provided such that nAvg is not an integer, or nAvg is greater than 256, the rate variable will be automatically adjusted to compensate and the user will be notified of the adjustment. Setting <outputRate> to 0 or not entering an outputRate value would cause the output data rate to equal <rate>. An error occurs for the following conditions: The outputRate is faster than rate ($nAvg < 1$).
RETURNS	Prompt when ready to accept a new command
EXAMPLE	SET RATE 5 >
EXAMPLE	SET RATE 100 10 >
EXAMPLE	SET RATE 850 20 Sample rate adjusted to 840.00Hz >
DEFAULT	5
RANGE	<.25 to 850> [<.125 to 425>]
NOTES	Using the optional Output Rate value cannot be used when TRIG == 1. It will be ignored.

SET FRAMES PER SCAN (FPS)

DESCRIPTION	Set the number of frames in a scan (can be used to scan for a duration of time)
SYNTAX	SET FPS <number of frames> Where <number of frames> is the number of frames in a scan. When set to 0 the scan continues until the STOP command is issued. To use FPS for duration, simply take RATE x SECONDS to get the FPS setting.
RETURNS	Prompt when ready to accept a new command
EXAMPLE	SET FPS 100 >
DEFAULT	0
RANGE	0 to 4294967295

SET SCAN UNITS (UNITS)

DESCRIPTION	Set the scan units
SYNTAX	SET UNITS <units> [user units] Where units is one of the following: PSI ATM BAR CMHG CMH2O DECIBAR FTH2O GCM2 INHG INH2O KNM2 KGM2 KGCM2 KPA KIPIN2 MPA MBAR MH2O MMHG NM2 NCM2 OZIN2 OZFT2 PA PSF TORR USER RAW When USER units are selected, the user units must be supplied.
RETURNS	Prompt when ready to accept a new command
EXAMPLE	SET UNITS PSI >

EXAMPLE	SET UNITS USER 1.50 >
EXAMPLE	SET UNITS RAW >
DEFAULT	PSI

SET SCANNING DATA FORMAT (FORMAT)

DESCRIPTION	Set the format of the scanned data for each of the destinations: Telnet, FTP and Binary Server.
SYNTAX	<p>SET FORMAT <destination> <format code> [,<destination> <format code>,<destination> <format code>]</p> <p>Where: <destination> is: T - Telnet (only A, F and C format code apply) F - FTP (only A, C, B, and S format codes apply) B - Binary server (only B,L and S format codes apply)</p> <p><format code> is: A - ASCII F - Formatted ASCII C - CSV format B - Binary format (.dat) See binary format definition below. L - LabVIEW binary format. See binary format for LabVIEW definition below. S - Statistical data (.dat) See statistical binary format definition below.</p>
RETURNS	Prompt when ready to accept a new command
EXAMPLE	SET FORMAT T F, F B, B B >
DEFAULT	T F, F B, B B
NOTES	The entire string does not need to be set if only changing one format. For example; if changing the FTP format to output CSV, use the command SET FORMAT F C

SET TRIGGER (TRIG)

DESCRIPTION	Sets the frame trigger
SYNTAX	<p>SET TRIG <trig></p> <p>Where <trig>:</p> <p>0 = External triggering is disabled. The MPS will scan using an internal trigger based on the RATE variable. Data is output based on the RATE setting, and can be executed using the SCAN command. Data output will stop when a STOP command is received, or FPS is met.</p> <p>1 = External frame trigger is enabled. The SCAN command must be used to place the MPS into SCAN mode. Once in scan mode, the MPS will listen for an external hardware trigger pulse to release a frame of data, a TRIG command, or a <TAB> character code (9 HEX or Control I). Every trigger or pulse sensed will output one frame of data. The MPS will return to READY mode when a STOP command is issued, or FPS has been met. Note that the Optional Output Rate setting cannot be used and will be ignored (See the RATE variable).</p> <p>2 = External scan trigger is enabled. The MPS will accept an applicable external voltage to execute a scan and stop the scan. Scanning will still adhere to the conditions of TRIG == 0.</p> <p>3 = Autostart is enabled. The MPS will start to scan and send data on power up (after the module's firmware has loaded). Scanning will still adhere to the conditions of TRIG == 0. See "Auto Scan Option" on page 26 for more information.</p>

RETURNS	Prompt when ready to accept a new command
EXAMPLE	SET TRIG 0 >
DEFAULT	0
RANGE	0, 1, 2 or 3
NOTES	Setting TRIG to 2 or 3 requires a SAVE or SAVE S command followed by a reboot in order for the change to take effect.
NOTES	When TRIG is set to 2 or 3, the SCAN and STOP commands are not disabled and will still work as expressed.

SET ENABLE FTP (ENFTP)

DESCRIPTION	Enables or disables sending data to the users FTP server.
SYNTAX	SET ENFTP <0-Disable, 1-Enable>
RETURNS	Prompt when ready to accept a new command
EXAMPLE	SET ENFTP 1 >
DEFAULT	0
RANGE	0 or 1

SET OPTIONS (OPTIONS)

DESCRIPTION	Set the subset size of the real time data analysis sample
SYNTAX	SET OPTIONS <fast scan> <read mode> <statistical scan subset size> Where <fast scan>: 0 – Normal scan 1 through 4 – Fast scan starting channel (see section on “Fast Scan Option (850Hz - 2500Hz)” on page 25) <read mode>: 0 – Normal statistical scan (<i>statistical mode disabled</i>) <statistical scan subset size>: Size is set to any value between 2 and 256. This value is the number of samples the statistical engine uses to calculate the statistical parameters.
RETURNS	Prompt when ready to accept a new command
EXAMPLE	SET OPTIONS 0 0 16 >
DEFAULT	0 0 16
RANGE	0 through 4, 0 or 1, 2 to 256

FTP VARIABLES (LIST FTP)

The FTP settings are used to control the MPS4000 FTP client connection to the FTP server, which is enabled by the ENFTP variable under LIST S.

LIST FTP SETTINGS (LIST FTP)

DESCRIPTION	Returns all of the FTP settings
SYNTAX	LIST FTP
RETURNS	All of the FTP setting followed by the prompt.
EXAMPLE	LIST FTP <i>SET USERFTP Scanivalve</i> <i>SET PASSFTP password</i> <i>SET PATHFTP /FTPDIR/Data</i> <i>SET IPFTP 10.0.1.222</i> <i>SET FILEFTP Scan</i> >

SET USER NAME (USERFTP)

DESCRIPTION	Sets the name of the user login on the FTP server or NAS
SYNTAX	SET USERFTP <user name>
RETURNS	Prompt when ready to accept a new command
EXAMPLE	SET USERFTP Scanivalve >
DEFAULT	Admin

SET FTP PASSWORD (PASSFTP)

DESCRIPTION	Sets the name of the user password for login on the FTP server or NAS
SYNTAX	SET PASSFTP <password>
RETURNS	Prompt when ready to accept a new command
EXAMPLE	SET PASSFTP password >
DEFAULT	Password

SET FTP PATH (PATHFTP)

DESCRIPTION	Set the directory path of the scan data file on the user's computer.
SYNTAX	SET PATHFTP <directory path>
RETURNS	Prompt when ready to accept a new command
EXAMPLE	SET PATHFTP /disk1/share >
DEFAULT	/disk1/share

SET FTP IP ADDRESS (IPFTP)

DESCRIPTION	Set the IP address of the users FTP server.
SYNTAX	SET IPFTP <IP Address>
RETURNS	Prompt when ready to accept a new command
EXAMPLE	SET PATHFTP 10.0.1.222 >
DEFAULT	10.0.0.1

SET FTP FILE NAME (FILEFTP)

DESCRIPTION	Set the base name for the scan data on the user's computer. The actual name will have the time and date appended to the file. It will have a file extension based on the data format.
SYNTAX	SET FILEFTP scan
RETURNS	Prompt when ready to accept a new command
EXAMPLE	SET FILEFTP Scan_117_ >
DEFAULT	SCAN

UDP VARIABLES

The UDP settings control the target and enable of scan data out the UDP port.

LIST UDP SETTINGS (LIST UDP)

DESCRIPTION	Returns all of the UDP settings
SYNTAX	LIST UDP
RETURNS	All of the setting followed by the prompt.
EXAMPLE	LIST UDP SET ENUDP 0 SET IPUDP 224.0.1.2 >

SET UDP ENABLE (ENUDP)

DESCRIPTION	Sets the UDP Enable
SYNTAX	SET ENUDP <0 or 1>
RETURNS	Prompt when ready to accept a new command
EXAMPLE	SET ENUDP 1 >
DEFAULT	0
RANGE	0 or 1
NOTES	SET FORMAT F B must be set for the MPS to send Binary data via UDP.

SET THE UDP TARGET ADDRESS AND PORT (IPUDP)

DESCRIPTION	Sets the UDP target address and the port. After setting this value a SAVE must be issued and the MPS4000 must be power cycled or rebooted for the changes to take effect.
SYNTAX	SET IPUDP <udpadd> <port> Where: <udpadd> - Is the target address for the UDP scan data. <port> - Is the target port.
RETURNS	Prompt when ready to accept a new command
EXAMPLE	SET IPUDP 224.0.1.2 23 >
DEFAULT	0.0.0.0

CALIBRATION AND VALIDATION COMMANDS**CALIBRATION**

DESCRIPTION	Starts a full or field calibration, single unit or multiple unit, as defined by the variables in LIST C and/or LIST O.
SYNTAX	[M]CAL [<F or FM> Where: M - prefix initiates a multiple unit calibration/validation. Leaving out the M is used for single unit processes. F - Initiates a single temperature field calibration, with no thermal chamber connection. MPS connection to a calibrator is required. FM - Initiates a manual, single temperature field calibration with no thermal chamber or calibrator connection. When the optional parameters are not present, the unit performs a full calibration.
RETURNS	Calibration data and a prompt when completed.
EXAMPLE	// perform a single unit full calibration, requiring Thermal Chamber and Calibrator control CAL [:::data:::] >
EXAMPLE	// perform a multi-unit field calibration, requiring Calibrator control MCAL F [:::data:::] >
EXAMPLE	// perform a single unit, manual field calibration CAL FM [:::data:::] >
NOTES	*A Scanivalve SPC4000 or SPC4050 is required for automated calibrations. An Ethernet controllable thermal chamber is required for full calibrations.

CALIBRATION & VALIDATION

DESCRIPTION	Starts a full or field calibration and validation sequence (continuous), as defined by the variables in LIST C and/or LIST O. A validation report is generated and stored in the MPS's file system.
SYNTAX	[M]CALVAL [<F or FM> Where: M - prefix initiates a multiple unit calibration/validation. Leaving out the M is used for single unit processes. F - Initiates a field calibration, followed by a field validation with no oven connection. MPS connection to a calibrator required. When the optional parameter is not present, the unit performs a full calibration/validation. FM - Initiates a single temperature manual field validation with no oven or calibrator connection When the optional parameters are not present, the unit performs a full calibration followed by a full validation.
RETURNS	Calibration and validation information and a prompt when completed.
EXAMPLE	// perform a single unit full calibration, followed by a full validation, requiring Thermal Chamber and Calibrator control CALVAL [:::data:::] >

EXAMPLE	// perform a single unit field calibration, followed by a field validation, requiring Calibrator control CALVAL F [:::data:::] >
EXAMPLE	// perform a manual, multi-unit field calibration, followed by a field validation MCALVAL FM [:::data:::] >
NOTES	A Scanivalve SPC4000 or SPC4050 is required for automated calibrations/validations. An Ethernet controllable thermal chamber is required for full calibration/validations.

VALIDATION

DESCRIPTION	Starts a full or field validation, as defined by the variables in LIST C and/or LIST O. A validation report is generated and stored in the MPS's file system.
SYNTAX	[M]VAL [<F or FM>] Where: M - prefix initiates a multiple unit calibration/validation. Leaving out the M is used for single unit processes. F - Initiates a single temperature field validation, with no oven connection. MPS connection to a calibrator required. FM - Initiates a single temperature manual field validation with no oven or calibrator connection. When the optional parameters are not present, the unit performs a full validation.
RETURNS	Validation Data
EXAMPLE	// perform a multi-unit full validation, requiring Thermal Chamber and Calibrator control MVAL [:::data:::] >
EXAMPLE	// perform a multi-unit field validation, requiring Calibrator control MVAL F [:::data:::] >
EXAMPLE	// perform a manual single unit field validation VAL FM [:::data:::] >
NOTES	A Scanivalve SPC4000 or SPC4050 is required for automated validations. An Ethernet controllable thermal chamber is required for full validations.

QUICK-ZERO OFFSET CALIBRATION (CALZ)

DESCRIPTION	Starts a zero calibration and places the MPS4000 into CALZ mode. This operation produces A/D count values for each pressure channel that is subtracted from the raw pressure counts before converting to the chosen pressure units. The CALZ is performed at the set RATE.
SYNTAX	CALZ
RETURNS	A prompt when ready for the next command.
EXAMPLE	CALZ >

NOTES	<p>A CALZ does not require additional equipment, is performed internally, and the command can be issued at any time.</p> <p>Typically, a CALZ is issued when the module is in the CALIBRATE valve state. This allows the CAL and REF ports to be tied together externally to provide an equal, or zero differential, pressure to the positive and negative sides of the transducer. This provides an optimal Quick-Zero Offset Correction.</p> <p>CALZ's can be performed when the module is in MEASUREMENT (Px) mode. This is typically performed in a "wind-off" condition, known as a "wind-off CALZ", where no pressure is being applied to the REF or Px ports of the module. This provides a Quick-Zero Offset Correction in the measurement state with no pressure applied.</p>
-------	--

CALIBRATION VARIABLES (LIST C)

The calibration settings control the calibration and validation of the MPS4000. See Section 6: Calibration and Validation Overview for more information on performing calibrations or validations.

LIST CALIBRATION SETTINGS (LIST C)

DESCRIPTION	Returns all of the calibration settings
SYNTAX	LIST C
RETURNS	All of the calibration settings followed by the prompt.
EXAMPLE	LIST C <i>SET NUMPTS 0 9 0 9</i> <i>SET MIN 40.000000 -5.500000 5.000000 -5.000000</i> <i>SET MAX 60.000000 5.500000 55.000000 5.000000</i> <i>SET DELAY 5 5</i> <i>SET IPOVEN 0.0.0.0 0</i> <i>SET IPCAL 0.0.0.0 0 1</i> <i>SET CALAVG 16 16</i> <i>SET VALZO 0</i> <i>SET FCAL 3 -5.00 5.00</i> <i>SET FVAL 3 -5.00 5.00</i> >

SET NUMBER OF POINTS IN CONVERSION TABLE (NUMPTS)

DESCRIPTION	Sets the number calibration and validation temperature and pressure points. This setting works with the MIN and MAX setting to the calibration and validation points.
SYNTAX	SET NUMPTS <tcal> <pcal> <tval> <pval> Where: <tcal> - Number of temperature points for a calibration. <pcal> - Number of pressure points for a calibration. <tval> - Number of temperature points for a validation. <pval> - Number of pressure points for a validation. These values are not range checked.
RETURNS	Prompt when ready to accept a new command
EXAMPLE	SET NUMPTS 15 25 3 15 >
DEFAULT	5 9 5 9
RANGE	<0 to 15> <0 to 25> <0 to 15> <0 to 25>

SET MINIMUM CALIBRATION AND VALIDATION VALUES (MIN)

DESCRIPTION	Sets the minimum calibration and validation temperature and pressure.
SYNTAX	SET MIN <tcal> <pcal> <tval> <pval> Where: <tcal> - Minimum temperature value for a calibration. <pcal> - Minimum pressure value for a calibration. <tval> - Minimum temperature value for a validation. <pval> - Minimum pressure value for a validation.
RETURNS	Prompt when ready to accept a new command
EXAMPLE	SET MIN 0 -5.5 10 -5.0 >
DEFAULT	0 -15 0 -15
RANGE	These values are not range checked.

SET MAXIMUM CALIBRATION AND VALIDATION VALUES (MAX)

DESCRIPTION	Sets the maximum calibration and validation temperature and pressure.
SYNTAX	SET MAX <tcal> <pcal> <tval> <pval> Where: <tcal> - Maximum temperature value for a calibration. <pcal> - Maximum pressure value for a calibration. <tval> - Maximum temperature value for a validation. <pval> - Maximum pressure value for a validation.
RETURNS	Prompt when ready to accept a new command
EXAMPLE	SET MAX 70 5.5 60 5.0 >
DEFAULT	70 15 70 15
RANGE	These values are not range checked.

SET OVEN AND CALIBRATOR DELAYS (DELAY)

DESCRIPTION	Sets the delay in minutes and seconds for the oven and calibrator, respectively.
SYNTAX	SET DELAY <iodelay> <odelay> <cdelay> <spcdelay> Where: <iodelay>- Initial oven delay in minutes. <odelay> - Oven delay in minutes. Setting this value to zero enables a stable query to the MPS (MPS must be +/-0.125°C for 10 minutes, 120 minute timeout). <cdelay> - Calibrator delay in seconds. Setting this value to zero uses the calibrator's STABLE command. <spcdelay> - Special Delay in seconds. This dwell is between the time between the positive applied points, and the negative applied points.
RETURNS	Prompt when ready to accept a new command
EXAMPLE	SET DELAY 120 45 0 200 >
DEFAULT	120 0 0 300
RANGE	These values are not range checked.

SET THE CALIBRATOR IP ADDRESS, PORT AND CALIBRATOR NUMBER (IPCAL)

DESCRIPTION	Sets the IP address and port for the calibrator. This is only applicable when using a Scanivalve SPC4000 or SPC4050 calibrator.
SYNTAX	SET IPCAL <ipadd> <port> <calibrator number> Where: <ipadd> - Calibrator IP address <port> - Calibrator port <calibrator address> - Calibrator's transducer address (1 - 4)
RETURNS	Prompt when ready to accept a new command
EXAMPLE	SET IPCAL 191.30.44.122 1025 2 >
DEFAULT	10.0.0.61 23 1
RANGE	These values are not range checked.
NOTES	When 0.0.0.0 0 0 is used, a simulated calibrator for debug is used.

SET THE CALIBRATION AND VALIDATION AVERAGE (CALAVG)

DESCRIPTION	Sets the number of samples taken from the MPS for a calibration and validation.
SYNTAX	SET CALAVG <calrate> <calavg> <valrate> <valavg> Where: <calrate> - Is the scan rate at which the samples are taken for the calibration. <calavg> - Is the number of sample taken for the calibration. Valid values range between 1 and 32000. <valrate> - Is the scan rate at which the samples are taken for the validation. <valavg> - Is the number of sample taken for the validation. Valid values range between 1 and 32000.
RETURNS	Prompt when ready to accept a new command
EXAMPLE	SET CALAVG 12 128 12 128 >
DEFAULT	0.9 16 0.9 16
RANGE	<0 to 850> <1 to 32000> <0 to 850> <1 to 32000>

SET ENABLE CALZ BEFORE VALIDATION (VALZO)

DESCRIPTION	When set a CALZ is performed at the start of each temperature during a validation.
SYNTAX	SET VALZO <0 or 1>
RETURNS	Prompt when ready to accept a new command
EXAMPLE	SET VALZO 1 >
DEFAULT	0
RANGE	0 or 1

SET FIELD CALIBRATION POINTS (FCAL)

DESCRIPTION	Sets the number of points and the min/max pressure for field calibration. Points will be evenly spaced between the minimum and maximum and will include a 0.00 point.
SYNTAX	SET FCAL <number of points> <minimum pressure> <maximum pressure>
RETURNS	Prompt when ready to accept a new command
EXAMPLE	SET FCAL 13 -5.00 5.00 >

DEFAULT	0
RANGE	These values are not range checked

SET FIELD VALIDATION POINTS (FVAL)

DESCRIPTION	Sets the number of points and the min/max pressure for field validation. Points will be evenly spaced between the minimum and maximum and will include a 0.00 point.
SYNTAX	SET FVAL <number of points> <minimum pressure> <maximum pressure>
RETURNS	Prompt when ready to accept a new command
EXAMPLE	SET FVAL 15 -5.00 5.00 >
DEFAULT	0
RANGE	These values are not range checked

OVEN VARIABLES (LIST O)

The oven settings control the thermal chamber when performing a multi-temperature calibration or validation of the MPS4000. These settings are only required if performing a full calibration or validation. Refer to Section 6: Calibration and Validation Overview for more information.

LIST OVEN SETTINGS (LIST O)

DESCRIPTION	Returns all of the oven settings
SYNTAX	LIST C
RETURNS	All of the oven settings followed by the prompt.
EXAMPLE	LIST O SET IPOVEN 0.0.0.0 0 SET STARTOVEN 0 SET STOPOVEN 0 SET TEMPOVEN 0 >

SET THE OVEN IP ADDRESS, PORT AND CALIBRATOR NUMBER (IPOVEN)

DESCRIPTION	Sets the IP address and port for the oven. When 0.0.0.0 0 0 is set no oven is used.
SYNTAX	SET IPOVEN <ipadd> <port> Where: <ipadd> - Calibrator IP address <port> - Calibrator port
RETURNS	Prompt when ready to accept a new command
EXAMPLE	SET IPOVEN 10.0.0.122 1025 >
DEFAULT	0.0.0.0 0
RANGE	These values are not range checked.

SET THE OVEN START COMMAND (STARTOVEN)

DESCRIPTION	Sets the command to send the oven to start
SYNTAX	SET STARTOVEN [<start oven command>] NOTE: If no command is entered, a CR is sent to the oven
RETURNS	Prompt when ready to accept a new command
EXAMPLE	SET STARTOVEN RUNM >
DEFAULT	0
RANGE	These values are not range checked.

SET THE OVEN STOP COMMAND (STOPOVEN)

DESCRIPTION	Sets the command to stop the oven.
SYNTAX	SET STOPOVEN [<stop oven command>] NOTE: If no command is entered, a CR is sent to the oven
RETURNS	Prompt when ready to accept a new command
EXAMPLE	SET STOPOVEN STOP >
DEFAULT	0
RANGE	These values are not range checked.

SET THE TEMPERATURE COMMAND (TEMPOVEN)

DESCRIPTION	Sets the command to send the oven to a temperature
SYNTAX	SET TEMPOVEN [<set temperature command>] NOTE: If no command is entered, a CR is sent to the oven
RETURNS	Prompt when ready to accept a new command
EXAMPLE	SET TEMPOVEN SETP1, >
DEFAULT	0
RANGE	These values are not range checked.

CONVERSION TABLE VARIABLES

The conversion table is responsible for converting raw pressure counts and temperature into accurate EU pressure.

LIST LEAST-SQUARED COEFFICIENTS (LIST T)

DESCRIPTION	Returns the least-squares and error correction coefficients.
SYNTAX	LIST T
RETURNS	<p>The least-squares conversion and error correction coefficients for each pressure channel, in the format:</p> <pre>SET K <channel> <k1> <k2> <k3> <k4> <k5> <k6> SET A <channel> <a1> <a2> <a3> <a4> SET B <channel> <b1> <b2> <b3> <b4> SET C <channel> <c1> <c2> <c3> <c4> SET D <channel> <d1> <d2> <d3> <d4></pre> <p>Where:</p> <p><channel> - is the pressure channel 1 to 64. <kn> - the least-squares coefficient value as used in the conversion equation. <a, b, c, dn> - the error correction coefficient used in the background task to obtain the respective A, B, C, or D coefficient for the current temperature.</p>
EXAMPLE	<p>LIST T</p> <pre>SET K 1 5.526097E-02 1.113042E-04 1.068045E-07 1.908862E-10 -1.825929E-07 5.010776E-16 ::: <channels 2 through 63> ::: SET K 64 1.824528E-02 1.728427E-05 1.125552E-07 1.937218E-10 8.462436E-08 6.297182E-16 SET A 1 5.418055E-29 -1.750566E-26 1.211565E-24 6.648985E-23 SET B 1 -1.037300E-22 -5.255588E-21 2.689422E-18 5.166433E-17 SET C 1 7.753362E-17 1.316558E-13 -9.490233E-12 6.842524E-11 SET D 1 4.354304E-10 2.671218E-08 -5.311249E-06 6.469795E-05 ::: <channels 2 through 63> ::: SET A 64 -1.042455E-28 -8.901835E-28 9.933755E-25 8.592377E-23 SET B 64 -5.249502E-22 4.515980E-20 7.136923E-19 -2.463333E-18 SET C 64 4.681487E-16 1.250421E-13 -1.269469E-11 8.363017E-11 SET D 64 -2.882084E-09 4.051924E-07 -1.732523E-05 1.873441E-04 ></pre>

SET COEFFICIENTS

DESCRIPTION	Sets conversion coefficients.
SYNTAX	<pre>SET <coefficient term> <channel> <term1> <term2> <term3> <term4> [<term5> <term6>]</pre> <p>Where:</p> <p><coefficient term> - is K, A, B, C, or D. <channel> - is the channel form 1 to 64. <term1-6> - are the coefficient correction values based on the term.</p>
RETURNS	Prompt when ready to accept a new command
EXAMPLE	<pre>SET A 32 1.000000 1.000000 1.000000 1.000000 ></pre>
NOTES	These values should never be manipulated manually.

FIELD CALIBRATION VARIABLES

The field calibration variables are responsible for storing correction terms created after a field calibration. These settings can only be saved using a SAVE FC command. Refer to Section 6: Calibration and Validation Overview for more information.

LIST FIELD CALIBRATION SETTINGS (LIST FC)

DESCRIPTION	Returns the field calibration correction coefficients and the field calibration correction status.
SYNTAX	LIST FC
RETURNS	All field calibration correction coefficients, plus the field calibration correction status. SET FCENABLE <status> SET FC <channel> <fc1> <fc2> <fc3> Where: <status> - is the status of the field calibration corrections. <channel> - is the pressure channel 1 to 64. <fcn> - the coefficient terms used in calculating the field calibration offset for correcting the EU pressure after conversion
EXAMPLE	LIST T SET FCENABLE 1 SET FC 1 -2.397058E-05 3.163599E-11 -6.514663E-18 SET FC 2 4.611204E-04 2.498326E-11 -1.436391E-17 SET FC 3 1.454991E-04 1.361265E-11 -2.081818E-18 :: <channels 4 through 62> :: SET FC 63 5.109234E-03 6.208174E-11 1.013237E-17 SET FC 64 1.061724E-03 3.800963E-11 -1.320103E-17 >

SET FIELD CALIBRATION CORRECTION STATUS

DESCRIPTION	Enables or disables the use of the stored field calibration correction coefficients.
SYNTAX	SET FCENABLE <status> Where <status> is: 0 - disabled (the standard coefficients are used). 1 - enabled (the field calibration correction terms are in use).
RETURNS	Prompt when ready to accept a new command.
EXAMPLE	SET FCENABLE 1 >

SET FIELD CALIBRATION COEFFICIENTS

DESCRIPTION	Sets the field calibration correction coefficients.
SYNTAX	SET FC <channel> <fc1> <fc2> <fc3> Where: <channel> - is the pressure channel 1 to 64. <fcn> - the coefficient terms used in calculating the field calibration offset for correcting the EU pressure after conversion.
RETURNS	
EXAMPLE	SET FC 1 -0.2397058 0.3163599 -0.6514663 >
NOTES	These values should never be manipulated manually.

MULTICAST COMMANDS**MULTIPLE UNIT FIND**

DESCRIPTION	Lists all of the MPS4264 devices in the multicast cluster of the master.
SYNTAX	MFIND
RETURNS	A list of MPS modules found in the multicast "cluster" followed by a prompt ready for the next command.
EXAMPLE	MFIND <i>Found device 0 IP Address 191.30.90.9</i> <i>Found device 1 IP Address 191.30.90.10</i>
NOTES	SVRSEL must be set to 1 for multicast command use.

MULTIPLE UNIT STOP

DESCRIPTION	Sent to stop multiple units when working with multiple devices. When the master receives the MSTOP command it issues a STOP command to the multicast address set in the MCAST variable. Each MPS member of this multicast cluster will stop scanning.
SYNTAX	MSTOP
RETURNS	Prompt ready for the next command.
EXAMPLE	MSTOP >
NOTES	SVRSEL must be set to 1 for multicast commands use.

MULTIPLE UNIT SCAN

DESCRIPTION	When the master receives the MSCAN command it issues a SCAN command to the multicast address set in the MCAST variable. Each MPS member of this multicast cluster will start scanning provided the SSD and SST conditions are met.
SYNTAX	MSCAN
RETURNS	The Scan Data
EXAMPLE	MSCAN >
NOTES	Output is based on formatting.

IP VARIABLES

The IP settings control the IP address and associated network identification settings of the MPS4000. The IP configuration is accessed by the command LIST IP. These settings can only be saved using the SAVE IP command.

LIST IP SETTINGS (LIST IP)

DESCRIPTION	Returns all of the IP settings
SYNTAX	LIST IP
RETURNS	All of the IP setting followed by the prompt.
EXAMPLE	LIST IP <i>SET IPADD 10.0.1.222</i> <i>SET SUBNET 255.255.0.0</i> <i>SET MAC 0.96.93.90.0.100</i> <i>SET LOGIN Scanivalve</i> <i>SET PASSWORD Scanner</i> <i>SET LOGIN1 Scanivalve1</i> <i>SET PASSWORD1 Scanner1</i> <i>SET ALLOWANON 1</i> <i>SET APP Mps4000.hex</i> <i>SET GW 0.0.0.0</i> <i>SET NAME MPS0000</i> >

SET IP ADDRESS OF THE MPS (IPADD)

DESCRIPTION	Sets the IP address of the MPS4000
SYNTAX	SET IP <ipadd> Where <ipadd> is any valid IP address in the form nnn.nnn.nnn.nnn When <ipadd> is set to 0.0.0.0 then DHCP is used. See page 18 for information on DHCP.
RETURNS	Prompt when ready to accept a new command
EXAMPLE	SET IPADD 10.0.1.222 >
DEFAULT	191.30.90.100
RANGE	Any valid IP address

SET SUBNET OF THE MPS (SUBNET)

DESCRIPTION	Sets the subnet mask for the MPS4000
SYNTAX	SET SUBNET <mask> Where <mask> is in the form nnn.nnn.nnn.nnn
RETURNS	Prompt when ready to accept a new command
EXAMPLE	SET SUBNET 255.255.0.0 >
DEFAULT	255.255.255.0
RANGE	Any valid subnet mask

SET LOGIN NAME (LOGIN)

DESCRIPTION	Sets the accepted login user name for the FTP server in the MPS4000
SYNTAX	SET LOGIN <user name> Where <user name> is any ASCII string with out spaces up to 64 characters long.
RETURNS	Prompt when ready to accept a new command
EXAMPLE	SET LOGIN SCANIVALVE >
DEFAULT	Scanivalve

SET PASSWORD FOR LOGIN NAME (PASSWORD)

DESCRIPTION	Sets the password for the accepted user names in LOGIN for the FTP server in the MPS 4000
SYNTAX	SET PASSWORD <password> Where <password> is any ASCII string with out spaces up to 64 characters long.
RETURNS	Prompt when ready to accept a new command
EXAMPLE	SET PASSWORD scanner >
DEFAULT	Scanner

SET LOGIN NAME 1 (LOGIN1)

DESCRIPTION	Sets an additional accepted login user name for the FTP server in the MPS4000
SYNTAX	SET LOGIN1 <user name> Where <user name> is any ASCII string with out spaces up to 64 characters long.
RETURNS	Prompt when ready to accept a new command
EXAMPLE	SET LOGIN1 SCANIVALVE1 >
DEFAULT	Scanivalve1

SET PASSWORD FOR LOGIN NAME 1 (PASSWORD1)

DESCRIPTION	Sets the password for the accepted user names in LOGIN1 for the FTP server in the MPS 4000
SYNTAX	SET PASSWORD1 <password> Where <password> is any ASCII string with out spaces up to 64 characters long.
RETURNS	Prompt when ready to accept a new command
EXAMPLE	SET PASSWORD1 scanner1 >
DEFAULT	Scanner1

SET ALLOW ANONYMOUS FTP LOGIN (ALLOWANON)

DESCRIPTION	Allows or prevents the FTP server to allow anonymous logins. When set to 1 the server accepts anonymous login when set to 0 the user must login with one of the two login name and password combination in LOGIN and LOGIN1.
SYNTAX	SET ALLOWANON <1 or 0>
RETURNS	Prompt when ready to accept a new command
EXAMPLE	SET ALLOWANON 1 >
DEFAULT	1
0 or 1	0 or 1

SET APPLICATION FILE NAME (APP)

DESCRIPTION	The file name of the application to run. This is the file name that is used when automatically running the application from the boot loader. It is also the file name used when using the RUN command. If this file is not found, an error is returned. File name is case sensitive.
SYNTAX	SET APP <file name> Where <file name> is the file name to run on start up. It is case sensitive.
RETURNS	Prompt when ready to accept a new command
EXAMPLE	SET APP Mps4000.hex >
DEFAULT	Mps4000.hex

SET GATEWAY (GW)

DESCRIPTION	This is the IP address of the network gateway used for network communication. If not present 0.0.0.0 must be used.
SYNTAX	SET GW <ip address> Where <ipadd> is any valid IP address in the form nnn.nnn.nnn.nnn
RETURNS	Prompt when ready to accept a new command
EXAMPLE	SET GW 10.0.2.123 >
DEFAULT	0.0.0.0

SET DNS NAME (NAME)

DESCRIPTION	This sets the name sent to the network DNS server to identify this MPS4000. When DNS name resolution is used.
SYNTAX	SET NAME <DNS name> Where <DNS name> is any ASCII string up to 64 characters. Spaces are not allowed.
RETURNS	Prompt when ready to accept a new command
EXAMPLE	SET NAME MPS0222 >
DEFAULT	MPS0000

MISCELLANEOUS VARIABLES

This is a collection of settings that are used for debugging or other setting.

LIST MISCELLANEOUS SETTINGS (LIST M)

DESCRIPTION	Returns all of the miscellaneous settings
SYNTAX	LIST M
RETURNS	All of the miscellaneous setting followed by the prompt.
EXAMPLE	LIST M SET SIM 0 SET ECHO 0 SET XITE 2 0 1 SET SVRSEL 1 SET TO 0 0 >

SET SIMULATION (SIM)

DESCRIPTION	Sets debugging and simulation modes.
SYNTAX	SET SIM <code in hex> Where <code in hex>: Bit 2 when set shows PTP calculated start differentials Bit 0 when set uses a prototype board
RETURNS	Prompt when ready to accept a new command
EXAMPLE	SET SIM 4 >
DEFAULT	0
RANGE	0 to 4
NOTES	Hex code greater than 4 will be ignored.

SET ECHO (ECHO)

DESCRIPTION	Sets echo for serial and Telnet communication.
SYNTAX	SET ECHO <0- no echo, 1-echo >
RETURNS	Prompt when ready to accept a new command
EXAMPLE	SET ECHO 1 >
DEFAULT	0
RANGE	0 or 1

SET EXCITATION (XITE)

DESCRIPTION	Sets excitation mode
SYNTAX	SET XITE <0-neg only, 1-pos only, 2-reg, 3-reversed polarity> <man A/D rate 0 for auto> <A/D Idle enabled>
RETURNS	Prompt when ready to accept a new command
EXAMPLE	SET XITE 2 0 1 >
DEFAULT	2 0 1
RANGE	<0,1 or 2> <0 to 9 or F> <0, 1>

SET SERVER SELECT (SVRSEL)

DESCRIPTION	Sets the type of network server. See section on socket allocation. After changing any of these settings a SAVE command must be issued and the device must be restarted.
SYNTAX	SET SVRSEL <1, 2, or 3> Where: 1 – Multicast server 2 – Binary server 3 – UDP scan data out
RETURNS	Prompt when ready to accept a new command
EXAMPLE	SET SVRSEL 1 >
DEFAULT	1
RANGE	1, 2, or 3

SET TIME OUT (TO)

DESCRIPTION	Set a configurable timeout for idle or half-closed TELNET connections.
SYNTAX	SET TO <timeout> [<keep-alive>] Where <timeout> is an interval of time in seconds following the last received input on an established TELNET connection before the MPS will perform the operation set by the keep-alive variable as described below. Any character sent over the Telnet connection will reset the timer. Where <keep-alive> is: 0 - The TELNET socket will be closed and will reopen in LISTEN mode. 1 - A TCP keep-alive packet will be sent to the host. If the keep-alive packet is acknowledged, then the TELNET connection will be maintained in ESTABLISHED state. If the keep-alive packet is not acknowledged (standard TCP retransmission/timeout protocol applies), the TELNET socket will be closed and will reopen in LISTEN mode. If keep-alive value is not provided, it will retain its previous value.
RETURNS	Prompt when ready to accept a new command
EXAMPLE	SET TO 300 1 >
DEFAULT	0 0
RANGE	<0 to 4294967295> [<0 or 1>]

SET DELAY REQUEST (DREQ)

DESCRIPTION	Changes the behavior of the PTP Delay_Request packet and timing. The actual delay request interval is influenced by a random number. The two settings help determine this number.
SYNTAX	SET DREQ <min delay> <range> Where <min delay> controls the minimum time between delay requests. Value used is the exponent of 2 to the nth power in seconds i.e. 0 is 1 second. Where <range> is the valid range of the random number, from 0 to 60 seconds.
RETURNS	Prompt when ready to accept a new command
EXAMPLE	SET DREQ 0 2 >
DEFAULT	0 2
RANGE	<-7 to 4> <0 to 60>

SET VALIDATION ERROR TOLERANCE (ETOL)

DESCRIPTION	Changes the error tolerance value set in the validation report generated by the MPS.
SYNTAX	SET ETOL <error> Where <error> is the value for the Full-Scale error percentage value for pass/fail limits. When set to '0', the MPS will use the default error percentage based on the pressure range (see specifications in Section 1 for accuracy error percentages).
RETURNS	Prompt when ready to accept a new command
EXAMPLE	SET ETOL 0.1 >
DEFAULT	0
RANGE	0 - 100

PRECISION TIME PROTOCOL VARIABLES (LIST PTP)

The precision time protocol settings control the PTP 1588 settings of the MPS4000. The PTP configuration is accessed by the command LIST PTP.

LIST PRECISION TIME PROTOCOL SETTINGS (LIST PTP)

DESCRIPTION	Returns all of the PTP settings
SYNTAX	LIST PTP
RETURNS	All of the PTP setting followed by the prompt.
EXAMPLE	LIST PTP SET PTPEN 1 SET STAT 0 SET SST 0:0:0.000000 SET SSD 1971/1/1 SET UTCOFFSET -7:00:00 >

SET PTP ENABLE (PTPEN)

DESCRIPTION	Enables the precision time protocol engine in the MPS4000. When PTPEN is set to 2, the MPS will serve as a PTP master
SYNTAX	SET PTPEN <status> Where <status> is: 0 – off 1 – PTP Slave unit 2 – PTP Master unit
RETURNS	Prompt when ready to accept a new command
EXAMPLE	SET PTPEN 1 >
DEFAULT	0
RANGE	0, 1 or 2

SET PTP STATISTICAL OUTPUT (STAT)

DESCRIPTION	Sets the destination of PTP statistical output
SYNTAX	SET STAT <level code> Where <level code> is: 0 – off 1 – serial 2 – network The statistical data is output in the following format: <ofm>, <msd>, <smd>, <mpd> ofm - Offset From Master. Time that slave and master differ in units of microseconds msd - Master to Slave Delay. Filtered packet delivery time from master to slave smd - Slave to Master Delay. Filtered packet delivery time from slave to master mpd - Mean Path Delay. Filtered mean path delay time
RETURNS	Prompt when ready to accept a new command
EXAMPLE	SET STAT 0 >
DEFAULT	0

RANGE	0 to 2
NOTES	Once set, the MPS will stream this data until SET STAT 0 is issued. A STOP command will not stop this stream of data.

SET SCAN START TIME (SST)

DESCRIPTION	Sets the time to start scanning as referenced to the grandmaster. The MPS4000 will use the current PTP time as the scan start time under two conditions: 1) When the PTP system is disabled via the SET PTPEN 0 command. 2) When the current time has not been received from the PTP server since the MPS4000 was powered up. Under this condition the MPS4000 time will start at Jan 1 1970, 0:00:00.000 hours, or epoch 0 time. This most likely will happen when there is no PTP server on the network. If the MPS4000 was enabled and then disabled after receiving a time set from the PTP time server, the MPS4000 will keep time from the last clock setting from the PTP server. When these two cases are not met, the MPS4000 uses the start time set via the SET SST <time> and SET SSD <date> setting in the PTP group.
SYNTAX	SET SST <hh:mm:ss.ffff> Where: hh-Hours, mm- Minutes, ss-Seconds and ffff is fractions of a second.
RETURNS	Prompt when ready to accept a new command
EXAMPLE	SET SST 13:00:00.000 >
DEFAULT	0:0:0.0000
RANGE	Any valid time

SET SCAN START DATE (SSD)

DESCRIPTION	Sets the date to start scanning as referenced to the grandmaster. See SST for more information.
SYNTAX	SET SSD <yyyy/mm/dd > Where: yyyy-Year, mm- Month, dd- Day
RETURNS	Prompt when ready to accept a new command
EXAMPLE	SET SSD 2016/08/10 >
DEFAULT	1971/1/1
RANGE	Any valid date

SET UTC OFFSET (UTCOffset)

DESCRIPTION	Sets the offset to be added or subtracted from network time.
SYNTAX	SET UTCOffset hh:mm:ss Where: hh - Hours from -12 to 12 mm - Minutes from 0 to 59 ss – Seconds from 0 to 59
RETURNS	Prompt when ready to accept a new command
EXAMPLE	SET UTCOffset -9:0:0 >
DEFAULT	0:0:0
RANGE	Any valid time

PTP (PRECISION TIME PROTOCOL) COMMANDS**CLEAR ACCUMULATED PTP STATISTICAL DATA**

DESCRIPTION	Clears the accumulated data in the histogram buffers and restarts sampling.
SYNTAX	PTPCLEAR
RETURNS	A prompt when ready for the next command.
EXAMPLE	PTPCLEAR <i>PTP Histogram Cleared</i> >

DISPLAY PTP STATISTICS

DESCRIPTION	Displays the accumulated data in histogram form.
SYNTAX	PTPSTAT
RETURNS	OFM, INTERVAL, <interval value>, <interval -6>, <interval -5>, <interval -4>, <interval -3>, <interval -2>, <interval -1>, <interval 0>, <interval 1>, <interval 2>, <interval 3>, <interval 4>, <interval 5>, <interval 6> A prompt when ready for the next command.
EXAMPLE	PTPSTAT <i>OFM, INTERVAL, 100000, 114, 13, 10, 23, 21, 15, 36, 6, 12, 9, 23, 10, 129</i> >

GET PTP TIME

DESCRIPTION	Gets the current PTP time as used by the MPS. Time is adjusted by UTCOFFSET.
SYNTAX	GETTIME
RETURNS	Current Time yyyy/mm/dd hh:mm:ss sec nnnn ns
EXAMPLE	GETTIME <i>Current Time 2014/2/6 0:23:52.0 sec 3335 ns 439809720</i> >

GET SCAN START TIME

DESCRIPTION	Gets the start time of the last scan. This command is valid in all modes. If no scan has been run since power up the following time is returned: 2015/1/1 0:0:0.000000
SYNTAX	SST
RETURNS	yyyy/mm/dd hh:mm:ss.nnnnnn
EXAMPLE	SST <i>2016/4/29 8:45:25.000000</i> >

GET UTC OFFSET

DESCRIPTION	Gets the current UTC offset.
SYNTAX	GETUTCO
RETURNS	- The current difference between TAI time and UTC time, in seconds, as supplied by the local grandmaster. - UTC updated flag - Set when UTC offset is valid.
EXAMPLE	GETUTCO <i>Current UTC Offset 0 0 0</i> >

SET PTP TIME

DESCRIPTION	Sets the current PTP time as used by the MPS. Time is adjusted by UTCOFFSET. When a grandmaster is active on the network, the time set by the SETTIME command is over written by the grand master time.
SYNTAX	SETTIME yyyy/mm/dd hh:mm:ss
RETURNS	Current Time yyyy/mm/dd hh:mm:ss sec nnnn ns
EXAMPLE	SETTIME 2016/6/22 14:20:0.00 <i>Entered 2016/6/22 14:20:0</i> <i>Time is 1466605200</i>

ELECTRIC VALVE COMMANDS

The following commands are specific to the EPx configurations of the MPS4264. These commands will not be acknowledged in any other MPS valve configuration, and will prompt and ERROR if attempted.

VALVE STATE - MEASUREMENT MODE (EPX)

DESCRIPTION	Changes the valve state to Px (Measurement) mode with the use of the internal motor.
SYNTAX	EPX
RETURNS	Prompt when ready to accept a new command
EXAMPLE	EPX >
NOTES	The command will not be accepted if the valve is already in Px mode. The valve state can be queried during transition using the STATUS command.

VALVE STATE - CALIBRATE MODE (ECAL)

DESCRIPTION	Changes the valve state to CAL mode with the use of the internal motor.
SYNTAX	ECAL
RETURNS	Prompt when ready to accept a new command
EXAMPLE	ECAL >
NOTES	The command will not be accepted if the valve is already in Cal or Purge mode. The valve state can be queried during transition using the STATUS command.

VALVE STATE - PURGE MODE (EPRG)

DESCRIPTION	Changes the valve state to PURGE mode with the use of the internal motor.
SYNTAX	EPRG
RETURNS	Prompt when ready to accept a new command
EXAMPLE	EPRG >
NOTES	The command will not be accepted if the valve is already in Purge or Cal mode. The valve state can be queried during transition using the STATUS command.

ELECTRIC ZERO-OFFSET CALIBRATION (ECALZ)

DESCRIPTION	Performs a CALZ after the valve state has been moved to CAL mode.
SYNTAX	ECALZ
RETURNS	Prompt when ready to accept a new command
EXAMPLE	ECALZ >
NOTES	This command will start a sequence in the electric valve that will perform the following: Transition valve state to CAL mode Perform a CALZ Transition valve state to Px mode The command will not be accepted if the valve is in Cal or Purge mode. This command is only designed to be used while in Px mode. This command may take 1 minute to complete.

[INTENTIONALLY LEFT BLANK]

SECTION 6: MAINTENANCE

FIRMWARE INSTALLATION & CONFIGURATION **FILE UPLOAD (WINDOWS XP, 7, 10)**

NOTE: Some firewalls may block file transfers. We recommend that firewalls be shut down for the procedures in this section.

1. Connect a host computer to the Ethernet port.
2. Locate the new or updated firmware (MpsXXX.TAR)
3. Open My Computer
4. In the Address Bar, type:
ftp://<IPAddress><Enter>
Where: <IPAddress> is the IP Address of the MPS4264.
5. The host computer should connect, if the connection is successful, the contents of the MPS4264 flash storage will be displayed in a folder format.
Find and delete the old MPSXXX.tar file.

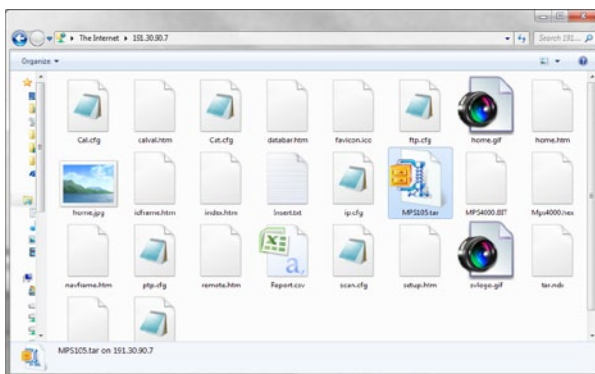
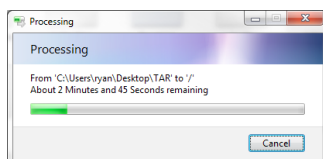

FIGURE 6-1: FLASH FILE CONTENTS

6. Open Windows Explorer in another window. Find the directory where the new MPSXXX.TAR file is stored. Highlight the file and
Click: Edit
Click: Copy
7. Select the MPS4264 window and,
Click: Edit
Click: Paste

The file will be copied to the MPS4264. A progress window will provide progress information.



8. Once the file has been copied, connect to the MPS. To “unpack” the .TAR file, send the command:

TAR <FILENAME>
(this command is case sensitive)

The MPS will display the status as it unpacks the file.

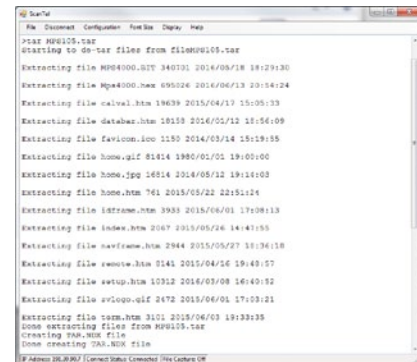

FIGURE 6-2: UNPACKING TAR FILE

- Once it is completed, verify the files were unpacked correctly by sending the command:

TARCHK

The MPS will display a confirmation that the files were unpacked successfully.

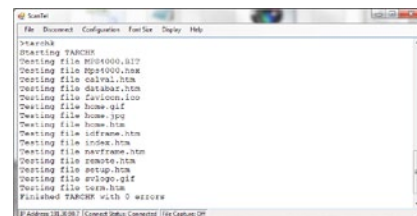

FIGURE 6-3: UNPACKING TAR FILE

- (See “TAR File Unpack” on page 43 and “Firmware Files Check” on page 41 for more information on the TAR and TARCHK commands.)

9. Cycle the AC power or execute a Reboot command to complete the process.

CALIBRATION COEFFICIENT INSTALLATION (WINDOWS XP, 7, 10)

NOTE: Some firewalls may block file transfers. We recommend that firewalls be shut down for the procedures in this section.

1. Connect a host computer to the Ethernet port.
2. Open My Computer
3. In the Address Bar, type:
ftp://<IPAddress><Enter>
Where: <IPAddress> is the IP Address of the MPS4264.
4. The host computer should connect. If the connection is successful, the contents of the MPS4264 flash storage will be displayed in a folder format.

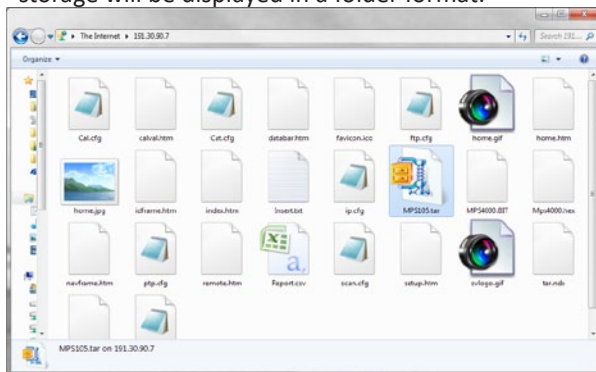

FIGURE 6-4: FLASH FILE CONTENTS

5. Open Windows Explorer in another window. Find the directory where the new calibration coefficients are stored. MPS4264 calibration coefficients are a text file called "Cal_<sn>.cfg" where <sn> is the serial number of the module.

Note: For all versions 2.11 and older, the file must be named "Cal.cfg" and cannot include the serial number.

Highlight the files to be copied to the MPS4264 and

Click: Edit

Click: Copy

6. Select the MPS4264 window and delete the existing cal.cfg file. Then,
Click: Edit
Click: Paste

The files will be copied to the MPS4264. A progress window will provide progress information.

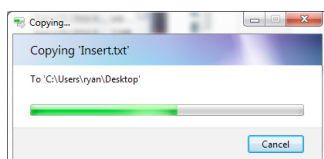

7. When the copy function is complete, the MPS4264 window will show the new files. The time and date of the new file can be used to confirm that the new files were uploaded successfully.
8. Cycle the AC power or execute a Reboot command to complete the process.

DIP SWITCHES & BOOTLOADER MODE

DIP SWITCHES

The MPS4264 has two DIP switches on the Power/Ethernet board. The configuration of the first DIP switch enables or disables detailed debug output from the unit. The configuration of the second DIP switch determines the module's function regarding when the module boots into the "application" file and when it is held in "bootloader" mode. The two switches are:

SW1 - When this switch is on, the boot loader will run in the debug mode. Debug output is directed to the serial port. Default is off.

SW2 - When this switch is on, the application automatically boots on power up. When this switch is off, the MPS4264 remains in the bootloader mode. Default is on.

**NOTE: The "ON" and "OFF" positions are the opposite of the "ON" label on the switches. Figure 6-6 shows the DIP switches with the "correct" position labels.*

WHEN TO OPERATE IN BOOTLOADER MODE

If the MPS will not boot, or appears to have lost communications with a Host, the system may be operated in the Bootloader Mode. This is a "safe mode" of sorts where the MPS stays in the "boot loader." In this mode of operation, the application will not start. All available commands may be entered by the Ethernet or Configuration ports. Typically, the only common reason to use this function is if the application file has been corrupted and the MPS is failing to boot from it correctly.

HOW TO OPERATE IN BOOTLOADER MODE

1. Power the MPS down and disconnect the power and Ethernet cable. Ensure proper ESD considerations are taken.



CAUTION! ESD PROTECTION REQUIRED. The proper use of grounded work surfaces and personal wrist straps are required when coming into contact with exposed circuits to prevent static discharge from damaging sensitive electronic components.

- Remove the two screws that mount the end cover in place. Carefully remove the end cover by sliding it vertically up. Care must be taken to not bend or move the power or Ethernet connector.

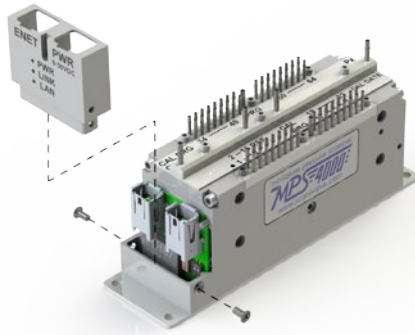

FIGURE 6-5: END COVER REMOVAL

- With the end cover removed, the DIP switches are accessible. To hold the unit in the bootloader and prevent it from booting into the application file, switch the #2 DIP switch downwards to the “OFF” position. NOTE: the switch is labeled with an “ON” label but for this application it is backwards. “ON” is up and “OFF” is down.

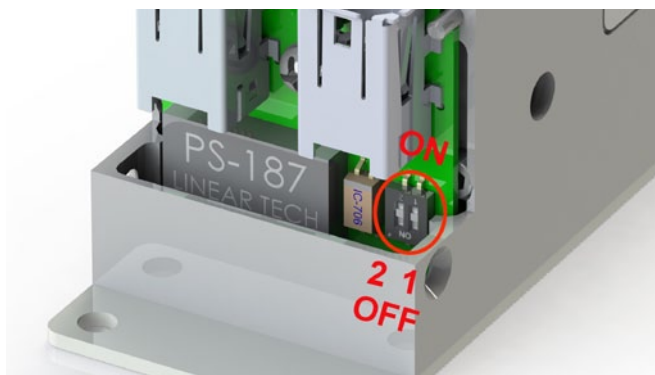

FIGURE 6-6: DIP SWITCHES

Note: in some iterations of the MPS, the power board dip switches were installed in reverse. If you do not get bootloader mode, reverse the switches.

- Reconnect the power and Ethernet cables. Re-apply power to the MPS4264. The application will not run, but the bootloader commands can be used to troubleshoot system problems.
- When troubleshooting is complete, remove power and reset switch #2 to the “ON” position. Reinstall the end cover and re-apply power.

FORMATTING THE FLASH DISK

Should the flash disk of the MPS need to be reformatted, it

can be done fairly simply if the following procedure is carefully followed. For most, but not all times that an MPS will be reformatted a serial connection needs to be available to communicate with the unit. If you are able to currently establish an Ethernet connection with the unit, the reformatting is not the best option. In that case, simply FTP to the unit, manually delete the contents of the directory and reload them using the procedure outlined in “Firmware Installation & Configuration File Upload (Windows XP, 7, 10)” on page 78. However, if an Ethernet connection cannot be established with the unit it is probably the case that the MPS application file or memory system has been corrupted and needs to be reformatted. The procedure for reformatting the MPS is as follows:

- Make sure the MPS is powered down and proper ESD considerations are taken.
- Following the procedure outlined in “How to operate in bootloader mode” on page 79, configure the DIP switch for bootloader mode with positioning switch #2 to “OFF.”
- Power the MPS on. If the IP address is known, you can attempt to connect to the unit via an Ethernet connection. If this is not successful, or if the IP address is not known you will need to connect using the serial port. Details on connecting to the serial port can be found in “Serial Communications” on page 16.
- Once a connection is established, send the command:

FDISK

The MPS will respond with “Type FDISKCONFIRM to confirm FDISK or STOP to escape” Follow the instructions and send the command:

FDISKCONFIRM

The MPS will respond indicating completion:

```
Start format
Erasing device 100
Done device 100
>
```

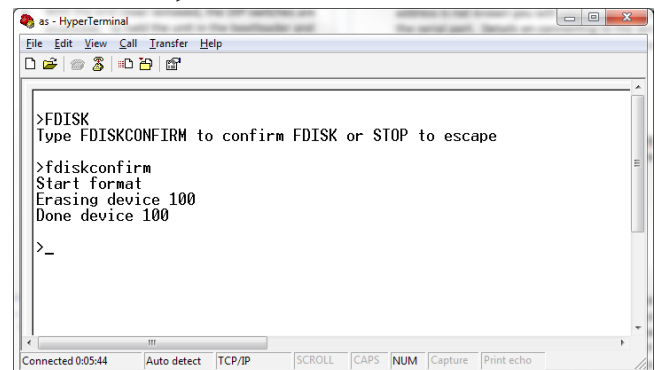

FIGURE 6-7: FDISK COMMAND

- At this point the flash disk has been reformatted and all contents have been deleted. All configuration settings, including the MPS's IP address have been deleted. Before the power is cycled the IP address needs to be set so Ethernet communications can be established. Send the command:

SET IPADD XXX.XXX.XXX.XXX

(where xxx.xxx.xxx.xxx is the desired IP address)

Followed by the command:

SAVEIP

SAVEIPCONFIRM

```

as - HyperTerminal
File Edit View Call Transfer Help
[Icons]
>FDISK
Type FDISKCONFIRM to confirm FDISK or STOP to escape
>fdiskconfirm
Start format
Erasing device 100
Done device 100
>SET IPADD 191.30.90.7
>SAVE IP
>
Connected 0:07:58  Auto detect  TCP/IP  SCROLL  CAPS  NUM  Capture  Print echo

```

FIGURE 6-8: RESET IP ADDRESS

- FTP to the MPS and drag-and-drop the two files:
MPS4000.hex
MPSXXX.tar

Using the procedure outlined in “Firmware Installation & Configuration File Upload (Windows XP, 7, 10)” on page 78.

- Power the MPS down, and reconfigure the DIP switches for normal operation with switch #1 “OFF” and switch #2 “ON.”
- Power the MPS back up and connect via the Ethernet connection as normal using the IP Address set in step # 5.
- Send the command:

TAR MPSXXX.TAR

(this command is case sensitive)

This “unpacks” the .TAR file and sets up the file structure of the MPS.

- At this point, the application files and web server files have been restored. The MPS is still missing the module’s unique calibration coefficients. A copy of these coefficients is supplied on a CD or USB drive with the module. Using the same procedure as Step #6, drag-and-drop the module’s calibration coefficients (Cal.cfg file). Cycling power again will pull these calibration coefficients into the working RAM. If the calibration coefficients cannot be located, please contact Scanivalve Corp. and provide your module’s exact model and serial number.

CALIBRATION & VALIDATION OVERVIEW

The MPS4200 uses stable, temperature compensated piezoelectric pressures sensors. The use of these sensors in the new design, along with the ability to perform frequent, online zero-offset calibrations (**CALZ**), allow the MPS4200 to hold published accuracy for up to 6 months. Scanivalve recommends performing a validations on MPS4200s using a high-accuracy pressure standard on a 6 month interval, and calibrating when required. Reports generated by the validation process are stored in the MPS's memory.

Every MPS4200 module is calibrated from the factory over a series of 15 temperatures between 0° and 70°C. At each temperature, 25 pressures are applied. This calibration creates a matrix of discrete temperatures and pressures, called the master calibration coefficients. The MPS4200 converts these points into a polynomial, least-squares fit. After calibration coefficients are created, a multi-temperature validation is performed over 3 temperatures from 10° to 60°C, applying 15 different pressures at each temperature.

Automated calibrations and validations require a Scanivalve SPC4000 or SPC4050 calibrator. Manual calibrations and validations can be performed using a non-Scanivalve calibrator. Performing a manual calibration requires user input, and manual application of pressures instructed by MPS.

All Calibration and Validation processes are handled internally, requiring no additional software on the host computer. The MPS4200 allows for single or multi-unit calibration and validations. Mutli-unit calibration or validations are controlled using a single MPS4200 device. Once this is configured properly, a calibration, validation, or calibration-validation can be performed on multiple units, using a single module as the master controller.

There are two calibration/validation types that can be performed in the MPS: Full Calibration and Validation, and Field Calibration and Validation.

FULL CALIBRATION & VALIDATION

A full calibration deletes all stored calibration coefficients and applies known pressures over a series of temperatures (as described in the previous section), followed by a multi-temperature validation. This duplicates what is performed at the factory during the module's original manufacture and calibration. Full calibration and validation requires an Ethernet controllable environmental chamber capable of reaching the entire 0°C and 70°C range, and a suitable, high-accuracy pressure standard. It is recommended that for full calibrations, the module be returned to Scanivalve or a certified Scanivalve Representative.

An automated full calibration/validation routine typically takes 20 hours or more.

FIELD CALIBRATION & VALIDATION

During a field calibration or validation, a series of pressures are applied to the module at a single temperature. The temperature of the module does not have to be controlled to a specific temperature, and does not require an environmental chamber. The MPS4200 calculates a second set of "field" coefficients at the current temperature of the MPS, which is then used as a correction term across the full coefficient table (0°-70°C). This technique is suitable for maintaining module's coefficients long-term in the field.

An automated field calibration/validation routine typically takes less than an hour.

FIELD CALIBRATION & VALIDATION PROCEDURE

The following section is a guide for performing field calibrations and/or validations on one or more MPS4200 modules. Automated Field Calibrations and Validations require version 3.00 and higher. Manual Field Calibrations and Validations require version 3.04 and higher.

SETUP AND CONFIGURATION

1. Connect power and Ethernet connections to each MPS module that will be calibrated or validated. Modules should be allowed one or more hours of warm-up time before a calibration or validation is performed.
2. Connect to each MPS module using ScanTel or similar, and set the following configurations:
SET SVRSEL 1<ENTER>
SET MCAST <unique multicast address><ENTER>
SET IPCAL <IP address of the calibrator> <port of calibrator> <calibrator channel><ENTER>
SET VALZO 1<ENTER>
SET FCAL <number of calibration points> <min cal pressure> <max cal pressure><ENTER>
SET FVAL <number of validation points> <min val pressure> <max val pressure><ENTER>

- Recommended settings can be found in later in this section, under Table 6-1.
- If a manual calibrator or pressure standard is to be used, ignore the IPCAL variable.
- Each device that will be calibrated or validated must be configured the same, unless there are different pressure ranges. Adjust accordingly.

3. [Optional] If SVRSEL or MCAST is altered, a **SAVE<ENTER>** and power cycle if required. Issue the **SAVE<ENTER>** command and wait for the save to complete. Once the prompt (>) is returned, issue the command:

REBOOT<ENTER>

Disconnect and close all instances of ScanTel that are open and allow time for the modules to reboot.

4. Make all necessary pneumatic connections to the MPS, including:
- Control Pressure to place module into Calibrate Mode
 - 65psi for CPx at CALCTL port.
 - 90-120psi for NPx at CALCTL port.
 - ECAL command for EPx.
 - Calibrator positive output to the CAL port.
 - Calibrator negative output to the REF port.

Note: applying a positive pressure to the REF port is used to calibrate the negative pressures.

5. Connect to a single MPS4200 using ScanTel and verify that all settings are correct. Issue the command:

VALVSTATE<ENTER>

Ensure that the module returns with **CAL** (Calibrate mode).

6. Leak checks, or trap and decay tests, and pressure response should be performed on both the CAL and REF port to ensure correct plumbing, and that there are no leaks present.

7. [Optional] For multiple module calibration/validations, issue the command:

MFIND<ENTER>

Ensure that all expected modules respond. If they do not, please check that all module's **SVRSEL** and **MCAST** variables match before continuing.

PERFORMING A SINGLE OR MULTI-FIELD CALIBRATION

A Field Calibration (single or multi-unit) will apply defined pressures from the calibrator in equal steps, at the current temperature of the module(s). This calibration create correction terms that are used across the full compensated range (0°-70°C). A validation is typically required after a calibration. The field calibration coefficients can be enabled or disabled at any time using the **FCENABLE** variable.

1. Follow the steps under Setup and Configuration.

2. [Optional] If a calibration log is required (for troubleshooting or requested by Scanivalve), start an ASCII capture file using ScanTel:

File > Start ASCII Capture

Name the file and save in a directory.

- 3.A. To start an automated single unit field calibration, issue the command:

CAL F<ENTER>

To start an automated multi-unit field calibration, issue the command:

MCAL F<ENTER>

The automated Field Calibration (single or multi) will begin. The process will stream information to the screen. When completed, the MPS will return a completed message, followed by a Prompt (>). If there is an issue, check the log to find the error and correct any noted errors.

- 3.B. To start a manual single unit field calibration, issue the command:

CAL FM<ENTER>

To start a manual multi-unit field calibration, issue the command:

MCAL FM<ENTER>

The manual Field Calibration (single or multi) will begin. The process will stream information to the screen. The MPS will prompt with steps on when to zero the calibrator, apply pressures, and enter in pressure readings. Follow the steps carefully.

4. Once a Field Calibration is complete, the field coefficients are stored in **LIST FC**. The field calibration process will automatically enable the field coefficients in all modules (**SET FCENABLE 1**). To save these coefficients, the issue the command:

SAVE FC<ENTER>

Saving the FC terms must be repeated for every module that was calibrated (connect using ScanTel and issue the command).

PERFORMING A SINGLE OR MULTI-FIELD VALIDATION

A Field Validation (single or multi-unit) will apply pressures from the calibrator at the current temperature of the modules, compare the EU readings to the calibrator readings, and find the percent error of full scale. This will validate the current coefficient table in the MPS module. This can be performed with or without field calibration coefficients (**FCENABLE**).

1. Follow the steps under Setup and Configuration.

2. [Optional] If a validation log is required (for troubleshooting or requested by Scanivalve), start an ASCII capture file using ScanTel:

File > Start ASCII Capture

Name the file and save in a directory.

- 3.A. To start an automated single unit field validation, issue the command:

VAL F<ENTER>

- To start an automated multi-unit field validation, issue the command:

MVAL F<ENTER>

The Field Validation (single or multi) will begin. The process will stream information to the screen. When completed, the MPS will return a completed message, followed by a Prompt (>). If there is an issue, check the log to find the error and correct any noted errors. If there is an issue, check the log to find the error and correct any noted errors.

- 3.B. To start a manual single unit field validation, issue the command:

VAL FM<ENTER>

- To start a manual multi-unit field validation, issue the command:

MVAL FM<ENTER>

The manual Field Validation (single or multi) will begin. The process will stream information to the screen. The MPS will prompt with steps on when to zero the calibrator, apply pressures, and enter in pressure readings. Follow the steps carefully.

4. Once the validation is completed, the report can be found on the MPS's system memory. Open "Windows Explorer" and in the address bar, type:

FTP://<IP address of the MPS> <ENTER>

Drag and drop (or copy and paste) the RptXXX.csv to the desktop for viewing. This must be repeated for every module that was validated.

PERFORMING A SINGLE OR MULTI-FIELD CALIBRATION-VALIDATION

A Field Calibration-Validation (single or multi-unit) will apply pressures from the calibrator at the current temperature of the modules, create and enable the field calibration coefficients, and then auto-perform a validation. This process allows for a single command to start a calibration and validation without additional user input.

1. Follow the steps under Setup and Configuration.
2. [Optional] If a calibration-validation log is required

(for troubleshooting or requested by Scanivalve), start an ASCII capture file using ScanTel:

File > Start ASCII Capture

Name the file and save in a directory.

- 3.A To start an automated single unit field calibration-validation, issue the command:

CALVAL F<ENTER>

- To start an automated multi-unit field calibration-validation, issue the command:

MCALVAL F<ENTER>

The Field Calibration-Validation (single or multi) will begin. The process will stream information to the screen. When completed, the MPS will return a completed message, followed by a Prompt (>). If there is an issue, check the log to find the error and correct any noted errors.

- 3.B. To start a manual single unit field calibration-validation, issue the command:

CALVAL FM<ENTER>

- To start a manual multi-unit field calibration-validation, issue the command:

MCALVAL FM<ENTER>

The manual Field Calibration-Validation (single or multi) will begin. The process will stream information to the screen. The MPS will prompt with steps on when to zero the calibrator, apply pressures, and enter in pressure readings. Follow the steps carefully.

The calibration process will automatically enable the field calibration coefficients (**SET FCENABLE 1**) before the validation. Once a Field Calibration-Validation is complete, the field coefficients are stored in **LIST FC**.

5. Once the validation is completed, the report can be found on the MPS's system memory. Open a window in "Windows Explorer" and in the address bar, type:

FTP://<IP address of the MPS> <ENTER>

Drag and drop (or copy and paste) the RptXXX.csv to the desktop for viewing. This must be repeated for every module that was validated.

6. If the module passes validation; in ScanTel, issue the command:

SAVE FC<ENTER>

Saving the FC terms must be repeated for every module that was calibrated (connect using ScanTel and issue the command).

MANUAL FIELD CALIBRATION-VALIDATION STEPS

When running a field calibration, validation, or calibration-validation, the MPS will output prompts to step through the process, including some information that may be used for troubleshooting. Here are the prompts and what they indicate:

“Zero or vent the pressure standard and press <ENTER> when stable”

Ensure the calibrator or pressure standard is vented or zero'd. This means no pressure is being applied to the MPS module, and the CAL/REF ports are connected to the same stable ambient or vented pressure. This is important for proper zero readings, as well as when the CALZ is performed during validations.

“Apply <value> PSI to the <npr> PSI module(s). When stable, input actual pressure standard reading in PSI and press <ENTER> to continue:”

This step will be given for each of the pressure points needed to calibrate or validate the module. A pressure in PSI units will be provided in <value>; for example 0.000 for the zero point, 2.5000 PSI for a positive pressure, or -1.7500 for a negative pressure.

The <npr> field will identify which modules to apply pressure to. This is useful when calibrating multiple modules with different pressure ranges.

Command the calibrator or pressure standard to apply <value> pressure (in PSI) to the MPS module, and allow the pressure to reach stability. Once stable, enter in the pressure reading at the calibrator or pressure standard with up to 6 decimal points and hit the enter key on the keyboard. Once the MPS is completed with the current pressure, it will provide the next pressure or step.

For the application of pressures with a manual calibrator or pressure standard, a gauge, differential, or absolute standard may be used.

For gauge standards, apply a positive gauge pressure to the cal port for all positive points, and apply a positive gauge pressure to the REF port for all negative points. For differential standards, apply a positive differential pressure to the cal port (ref left open to atmosphere), and for negative pressures, either apply a positive differential to the REF port or use a vacuum pump to draw down the differential sensor while the calibrator is connected to the CAL port.

For absolute standards, note the “zero” reading of the calibrator (will be a barometric PSIA value) when zero'd or vented. For positive pressure, add <value> to the PSIA reading and command the calibrator to apply that pressure to the CAL port. For negative pressures, either repeat the process connected to the REF port, or use a vacuum pump to draw down the absolute pressure while the calibrator is connected to the CAL port.

TABLE 6-1: RECOMMENDED CAL/VAL SETTINGS

The following table shows Scanivalve's recommended settings for MPS4264 Field Calibration and Validations.

Typical Full Scale Range	Min Val Pressure	Max Val Pressure	Min Cal Pressure	Max Cal Pressure	Field-Cal Number of Points	Field-Val Number of Points	CALAVG
4" H2O	-0.145	0.145	-0.159	0.159	5 to 13	7 to 15	1 16 1 16 - or - 12 128 12 128
8" H2O	-0.289	0.289	-0.318	0.318			
10" H2O	-0.36	0.36	-0.396	0.396			
1 psid	-1	1	-1.1	1.1			
2.5 psid	-2.5	2.5	-2.9	2.9			
5 psid	-5	5	-5.5	5.5			
15 psid	-15	15	-16.5	16.5			
25 psid	-15	25	-16.5	27.5			
50 psid	-15	50	-16.5	60.5			

APPENDIX

APPENDIX A - INTRA-FRAME A/D TIMING

The rate setting controls the rate that each frame is sampled. The output rate may vary slightly based on the network loading and latencies. This section describes the timing of each pressure channel within a frame.

The hardware consists of 16 A/D chips, with each chip having 4 inputs. This arrangement produces 64 channels of pressure data. The 4 A/D channels are read sequentially. The relationship between the A/D chips, A/D channels and the pressure channels are shown in the map below:

A/D	CHIP 1	CHIP 2	CHIP 3	CHIP 4	CHIP 5	CHIP 6	CHIP 7	CHIP 8
CHAN 1	1	5	9	13	17	21	25	29
CHAN 2	2	6	10	14	18	22	26	30
CHAN 3	3	7	11	15	19	23	27	31
CHAN 4	4	8	12	16	20	24	28	32

A/D	CHIP 9	CHIP 10	CHIP 11	CHIP 12	CHIP 13	CHIP 14	CHIP 15	CHIP 16
CHAN 1	36	40	44	48	52	56	60	64
CHAN 2	35	39	43	47	51	55	59	63
CHAN 3	34	38	42	46	50	54	58	62
CHAN 4	33	37	41	45	49	53	57	61

The following table shows the timing of the start of each pressure channel A/D sample relative to the start of each frame:

TIME	CHAN	TIME (NOTE 1)	CHAN	TIME (NOTE 1 & 2)	CHAN	TIME (NOTE 1)	CHAN
0.0us	1	P/4 + 0us	2	2P/4 + 8.4us	3	3P/4 + 0us	4
4.4us	5	P/4 + 4.4us	6	2P/4 + 12.8us	7	3P/4 + 4.4us	8
8.8us	9	P/4 + 8.8us	10	2P/4 + 17.2us	11	3P/4 + 8.8us	12
13.2us	13	P/4 + 13.2us	14	2P/4 + 21.6us	15	3P/4 + 13.2us	16
17.6us	17	P/4 + 17.6us	18	2P/4 + 26us	19	3P/4 + 17.6us	20
22.0us	21	P/4 + 22us	22	2P/4 + 30.4us	23	3P/4 + 22us	24
26.4us	25	P/4 + 26.4us	26	2P/4 + 34.8us	27	3P/4 + 26.4us	28
30.8us	29	P/4 + 30.8us	30	2P/4 + 39.2us	31	3P/4 + 30.8us	32
35.2us	36	P/4 + 35.2us	35	2P/4 + 35.2us	34	3P/4 + 35.2us	33
39.6us	40	P/4 + 39.6us	39	2P/4 + 48us	38	3P/4 + 39.6us	37
44.0us	44	P/4 + 44.0us	43	2P/4 + 52.4us	42	3P/4 + 44.0us	41
48.4us	48	P/4 + 48.4us	47	2P/4 + 56.8us	46	3P/4 + 48.4us	45
52.8us	52	P/4 + 52.8us	51	2P/4 + 61.2us	50	3P/4 + 52.8us	49
57.2us	56	P/4 + 57.2us	55	2P/4 + 65.6us	54	3P/4 + 57.2us	53
61.6us	60	P/4 + 61.6us	59	2P/4 + 70us	58	3P/4 + 61.6us	57
66.0us	64	P/4 + 66.0us	63	2P/4 + 74.4us	62	3P/4 + 66.0us	61

Notes:

1. $P = 1 / \text{Rate}$
2. 8.4us is added to all times in this column due to temperature read during scan.

APPENDIX B - INTERNAL SOCKET ALLOCATION

The following is the socket allocation for the MPS 4000:

SOCKET ALLOCATION	
SOCKET	ALLOCATION
0	PHY Control Frames
1	FTP Server Control (Primary) – when not scanning FTP Client – when scanning Calibration Client MPS Master Telnet Client to Slave
2	Data Server (Primary) FTP Data Client FTP Data Server MPS Master Oven Client DHCP Communication
3	PTP Event 319
4	PTP General 320
5	Web Server
6 *	Multicast Server (Default, set with SVRSEL set to 1) Binary Server (Set with SVRSEL set to 2) UDP Server (Set with SVRSEL set to 3)
7	Telnet Server

* Note: Socket 6 action is selected with the SVRSEL variable. Changing this variable's setting requires a save and reboot.

APPENDIX C - LABVIEW CLIENT EXAMPLE

Below is an example LabVIEW VI to show how to interface with the MPS 4000 binary server. The frame structure to the left connects to the MPS4000 binary server with port 503 and prompts the user to enter a file name for the text file that will hold the scan data in CSV format.

The next frame structure to the right creates a queue and starts the scan by writing a 1 to the binary server. A queue is used between the producer loop and the consumer loop to handle differences between sampling rates and writing rates.

The next frame structure to the right supports the produce loop and the consumer loop.

The producer loop reads the data from the MPS4000 binary server. The MPS data is formatted such that the VI cast function can convert it directly to 66 single elements per frame or 264 bytes. This example runs the produce loop at 1ms, but this could be run at a slower period when the rate of the MPS is slower.

Multiple frames of data from the MPS may be read at once, however this will cause multiple frames of data in one array. For instance if 4 frames of data are desired with one read, the number of bytes to read is (4 X 264) or 1056 bytes. This allows the period of the producer loop to be reduced but the spreadsheet will then have 4 frames of data in one row. Additional LabVIEW functions, or spreadsheet post processing functions, are required to split out each data frame when multiple frames are read.

In tests with the produce loop set at a period of 1ms, and the read size set equal to 1 frame, data rates to 850 Hz are possible.

The consumer loop reads data from the queue, displays it to the front panel, converts the data to a string formatted for a CSV file, and writes the data to a CSV file. When an error is received from the queue, because the queue was closed from the producer loop, the consumer loop exits and closes the CSV file.

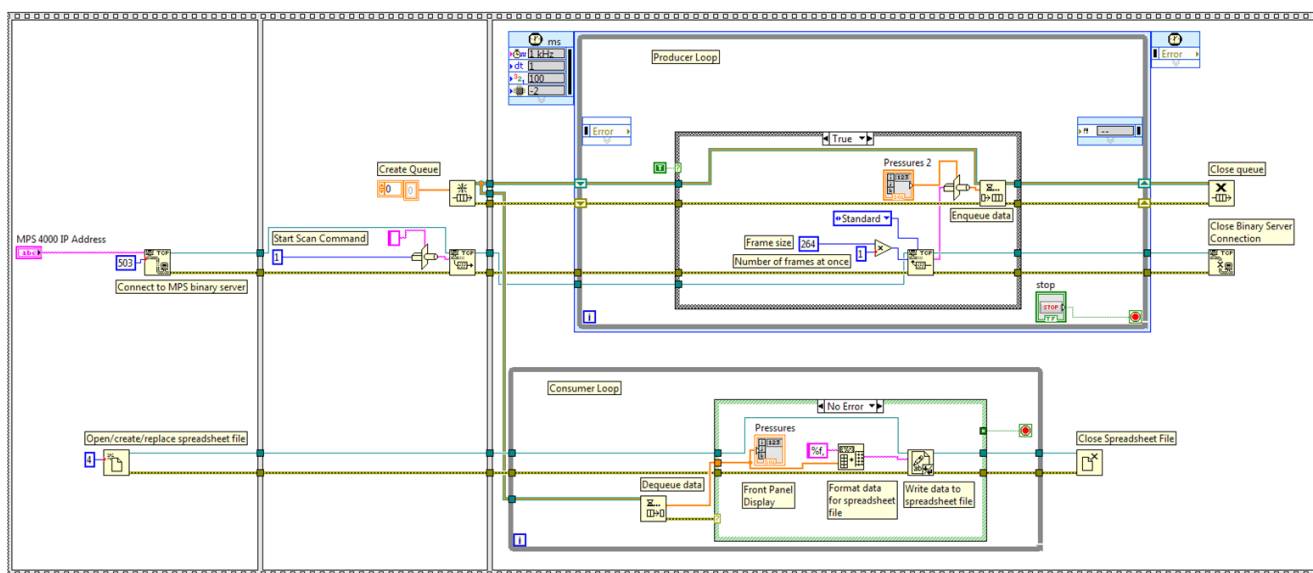

Scanivalve has created a standalone MPS4264 program titled MPSLink, that will interface with up to 8x MPS4264 modules, scan and collect data at the maximum rate (850Hz per 64 channels), and will convert all data to a single .CSV file. This program is available for download on the Scanivalve website, under Software Downloads. Included in the download are all VI's that were used to create the program. These VI's can be useful examples when developing custom LabVIEW software.

APPENDIX D - 1588 SYNCHRONIZED SCAN START

The 1588 protocol allows multiple MPS4000 units to start scanning at a preset time while keeping their data sample time synchronized. The scan start preset time, SSD and SST, could be a future time or a time past. The following tables show the time line for both cases. Please note that the frame timestamp is always relative to the start of scan time.

The following table describes a start scan with two MPS4000 units with internal trigger when the setting of SSD and SST are in the future.

SCAN START WITH FUTURE START TIME FOR 2 MPS4264 MODULES, INTERNAL TRIGGER							
SSD SET TO 6/1/2020							
SST SET TO 12:00:00							
RATE SET TO 1Hz							
1588 DATE AND TIME	EVENT	MPS A FRAME	MPS B FRAME	MPS A FRAME TIME STAMP	MPS B FRAME TIME STAMP	MPS A EXT TRIG TIME STAMP	MPS B EXT TRIG TIME STAMP
6/1/2020 11:59:58.00							
6/1/2020 11:59:58.50	Scan to MPS A						
6/1/2020 11:59:59.00							
6/1/2020 11:59:59.75	Scan to MPS B						
6/1/2020 12:00:00.00							
6/1/2020 12:00:01.00		1	1	1.0	1.0	0	0
6/1/2020 12:00:02.00		2	2	2.0	2.0	0	0

The following table describes a start scan with two MPS4000 units with internal trigger when the setting of SSD and SST are in the past. The MPS always starts on a period (1/rate) interval from the setting of the SSD and SST.

SCAN START WITH PAST START TIME FOR 2 MPS4264 MODULES, INTERNAL TRIGGER							
SSD SET TO 6/1/2020							
SST SET TO 11:59:58							
RATE SET TO 1Hz							
1588 DATE AND TIME	EVENT	MPS A FRAME	MPS B FRAME	MPS A FRAME TIME STAMP	MPS B FRAME TIME STAMP	MPS A EXT TRIG TIME STAMP	MPS B EXT TRIG TIME STAMP
6/1/2020 11:59:58.00							
6/1/2020 11:59:59.00							
6/1/2020 11:59:59.75	Scan to MPS A						
6/1/2020 12:00:00.00							
6/1/2020 12:00:00.25	Scan to MPS B						
6/1/2020 12:00:01.00		1		1.0		0	
6/1/2020 12:00:02.00		2	1	2.0	1.0	0	0
6/1/2020 12:00:03.00		3	2	3.0	2.0	0	0

The following table describes a start scan with two MPS4000 units with external trigger when the setting of SSD and SST are in the past. The MPS always starts on a period (1/rate) interval from the setting of the SSD and SST. The external trigger time stamp indicates when the external trigger occurred in 1588 time.

SCAN START WITH PAST START TIME FOR 2 MPS4264 MODULES, EXTERNAL TRIGGER							
SSD SET TO 6/1/2020							
SST SET TO 11:59:58							
RATE SET TO 1Hz							
1588 DATE AND TIME	EVENT	MPS A FRAME	MPS B FRAME	MPS A FRAME TIME STAMP	MPS B FRAME TIME STAMP	MPS A EXT TRIG TIME STAMP	MPS B EXT TRIG TIME STAMP
6/1/2020 11:59:58.00							
6/1/2020 11:59:59.00							
6/1/2020 11:59:59.75	Scan to MPS A						
6/1/2020 12:00:00.00							
6/1/2020 12:00:00.25	Scan to MPS B						
6/1/2020 12:00:01.00							
6/1/2020 12:00:02.00							
6/1/2020 12:00:02.57	External Trig						
6/1/2020 12:00:03.00		1	1	3.0	3.0	6/1/2020 12:00:02.57	6/1/2020 12:00:02.57
6/1/2020 12:00:04.00							
6/1/2020 12:00:04.29	External Trig						
6/1/2020 12:00:05.00		2	2	5.0	5.0	6/1/2020 12:00:04.29	6/1/2020 12:00:04.29

APPENDIX E - ENGINEERING UNIT CONVERSION CONSTANTS

UNITS Setting	Engineering Unit	Binary Index	PSI to EU 1 psi =	EU to PSI 1 EU =
PSI	Pound per square Inch	0	1 psi	1 psi
ATM	Atmospheres	1	0.068046 A	14.6960 psi
BAR	Bars	2	0.068947 b	14.5039 psi
CMHG	Centimeter of Mercury	3	5.17149 cmHg	0.193368 psi
CMH2O	Centimeter of Water	4	70.308 cmH2O	0.014223 psi
DECIBAR	Decibar	5	0.68947 db	1.4504 psi
FTH2O	Foot of Water	6	2.3067 ftH2O	0.43352 psi
GCM2	Gram per square Centimeter	7	70.306 g/cm2	0.014224 psi
INHG	Inch of Mercury @ 0C	8	2.0360 inHg	0.491159 psi
INH2O	Inch of Water @ 4C	9	27.680 inH2O	0.036127 psi
KGCM2	Kilogram per square Centimeter	10	0.0703070 kg/cm2	14.2235 psi
KGM2	Kilogram per square Meter	11	703.069 kg/m2	0.0014223 psi
KIPIN2	kips per square inch(ksi)	12	0.001 kip/in2	1000.0 psi
KNM2	Kilonewton per square Meter	13	6.89476 kN/m2	0.145038 psi
KPA	Kilopascal	14	6.89476 kPa	0.145038 psi
MBAR	Millibar	15	68.947 mb	0.014504 psi
MH2O	Meter of Water	16	0.70309 mH2O	1.42229 psi
MMHG	Millimeter of Mercury	17	51.7149 mmHg	0.0193368 psi
MPA	Megapascal	18	0.00689476 Mpa	145.038 psi
NCM2	Newton per square Centimeter	19	0.689476 N/cm2	1.45038 psi
NM2	Newton per square Meter	20	6894.759766 N/m2	0.000145038 psi
OZFT2	Ounce per square Foot	21	2304.00 oz/ft2	0.000434028 psi
OZIN2	Ounce per square Inch	22	16.00 in/ft2	0.062500 psi
PA	Pascal	23	6894.759766 Pa	0.000145038 psi
PSF	Pound per square Foot	24	144.00 lb/ft2	0.00694444 psi
TORR	Torr	25	51.714901 T	0.0193368 psi
USER	User Defined	26		
RAW	RAW A/D Counts	27	n/a	n/a

APPENDIX F - CABLE DRAWINGS AND PINOUTS

MPS PREMIUM POWER/SERIAL/TRIGGER CABLE

NOTES:
 ▲ REFER TO DRAWING 156062-70 CABLE ASSEMBLY.
 ▲ USE CRIMP TOOL PHT-68-45-S.
 ▲ TRIM CONNECTOR LEADS APPROXIMATELY 3 IN.
 ▲ USE 3/32 CLEAR HEAT SHRINK ON GROUND WIRE.

156085-1-2

REVISIONS			
REV	DESCRIPTION	DATE	APPROVED
A	ECN H-985	7-26-16	BCB
DDC	UPDATE TITLE	8-5-16	SH
B	ECN J-083	3-16-17	SH

-1 PREMIUM MPS POWER/SERIAL/TRIGGER CABLE

LENGTH PER CUSTOMER ORDER (FEET)
COONER CW6803REV1

1	YEL	FX	YEL
2	GRY	TX	GRY
3	BRN	GND	BRN
4	BLU	+TRIG	BLU
5	GRN	-TRIG	GRN
6	WHT	7-36 RTN	WHT
7	RED	7-36 VIN	RED
8	BLK	7-36 RTN	BLK

-2 PREMIUM MPS POWER/SERIAL/TRIGGER CABLE W/FLYING LEADS

-	V	O.S.	3/32" FIT 221	CLEAR HEAT SHRINK	7
-	V	O.S.	3/16" FIT 221	BLACK HEAT SHRINK	6
1	1	REF	156062-70	CABLE ASSEMBLY	5
V	V	O.S.	9/10" FIT 221	1/4" DIA. HEAT SHRINK, BLACK	4
V	V	O.S.	4471	LOCTITE	3
1	1	O.S.	CW6803REV1	STRANDED FLEXIBLE CABLE, 457 28AWG SHIELDED, 1660A	2
1	2	STK	156063-2	CONNECTOR SHELL REWORK	1
-2	-1	LOCATOR	PART NUMBER	DESCRIPTION	ITEM NO.

DATE		NAME		Scanivalve LIBERTY LAKE, WA	
DRAWN	3-31-15	SH			
CHECKED	3-31-15	C/JH		TITLE: PREMIUM MPS PWR/SER/TRIG CABLE	
ENGINEER	3-31-15	C/JH			
MODEL REV:					
ASSEMBLY DRAWING		SIZE	DWG. NO.	REV	
		B	156085	-	
CAD: SOLIDWORKS 2017		SCALE:	N/A	ERO#:	A-953 SHEET 1 OF 1

MPS POWER/TRIGGER CABLE WITH FLYING LEADS

NOTES:
 ▲ TRIM CONNECTOR LEADS APPROXIMATELY 3in.
 ▲ REFER TO DRAWING 156062-70 FOR CABLE CONNECTOR ASSEMBLY.
 ▲ USE CRIMP TOOL PHT-68-45-S.
 ▲ USE 3/32 CLEAR HEAT SHRINK ON GROUND WIRE.
 ▲ OVERALL LENGTH = 3 FEET.

156063-1

REVISIONS			
REV	DESCRIPTION	DATE	APPROVED
-	PRODUCTION RELEASE	8-19-16	SH

-1 MPS POWER/TRIGGER CABLE W/FLYING LEADS (3 FT.)

LENGTH PER CUSTOMER ORDER (FEET)
COONER CW6803REV1

1	YEL	FX	YEL
2	GRY	TX	GRY
3	BRN	GND	BRN
4	BLU	+TRIG	BLU
5	GRN	-TRIG	GRN
6	WHT	7-36 RTN	WHT
7	RED	7-36 VIN	RED
8	BLK	7-36 RTN	BLK

DATE		NAME		Scanivalve LIBERTY LAKE, WA	
DRAWN	7-13-16	SH			
CHECKED	7-13-16	C/JH		TITLE: MPS POWER/TRIGGER CABLE W/FLYING LEADS	
ENGINEER	7-13-16	C/JH			
MODEL REV: A					
ASSEMBLY DRAWING		SIZE	DWG. NO.	REV	
		A	155625	-	
CAD: SOLIDWORKS 2016		SCALE:	N/A	ERO#:	A-953 SHEET 1 OF 1

V	O.S.	3/16" FIT 221	BLK HEAT SHRINK	6
V	O.S.	3/32" FIT 221	CLEAR HEAT SHRINK	5
V	O.S.	9/10" FIT 221	1/4" DIA. HEAT SHRINK, BLK	4
V	O.S.	4471	LOCTITE	3
1	O.S.	3203 SI005	CABLE 4 COND 26AWG SHLD., 3 FT.	2
1	STK	156063-2	CONNECTOR SHELL REWORK	1
-1	LOCATOR	PART NUMBER	DESCRIPTION	ITEM NO.

MPS PREMIUM ETHERNET CABLE

NOTES:
 1. LENGTH PER CUSTOMER ORDER (200 FT. MAX)
 2. REFER TO DRAWING 156062-70 CABLE ASSEMBLY.
 3. USE CRIMP TOOL PHT-68-45-S.

156091-1

REVISIONS			
REV	DESCRIPTION	DATE	APPROVED
A	ECN H-985	7-26-16	BCB
DDC	UPDATE TITLE	8-5-16	SH

-1 PREMIUM MPS ETHERNET CABLE (MPS~ES4000 SWITCH)

REF	DESCRIPTION	ITEM NO.
1	156062-70 CABLE ASSEMBLY	5
V	O.S. 9/10" FIT 221 1/4" DIA. HEAT SHRINK, BLACK	4
V	O.S. 4471 LOCTITE	3
1	O.S. CW6803REV1 STRANDED FLEXIBLE CABLE, 4pr 28AWG SHIELDED, .166DIA	2
2	STK 156063-1 CONNECTOR SHELL REWORK	1

LOCATOR	PART NUMBER	DESCRIPTION	ITEM NO.
-1		Scanivalve LIBERTY LAKE, WA	
DRAWN	DATE	NAME	
2-2-16	SH		
CHECKED	2-2-16	CJH	
ENGINEER	2-2-16	CJH	
MODEL REV: B		TITLE: PREMIUM MPS ETHERNET CABLE (MPS~ES4000 SWITCH)	
ASSEMBLY DRAWING	SIZE	DWG. NO.	REV
	A	156091	A
CAD: SOLIDWORKS 2014		SCALE: N/A	ERO#: A-970
SHEET 1 OF 1			

MPS TO FEMALE RJ45

NOTES:
 1. REFER TO DRAWING 156062-70 CABLE ASSEMBLY.
 2. USE CRIMP TOOL PHT-68-45-S.
 3. MEASURE 3 FT. CABLE LENGTH FOR AE-313 (FACTORY LENGTHS VARY).

156110-1

REVISIONS			
REV	DESCRIPTION	DATE	APPROVED
-	PRODUCTION RELEASE	7-29-16	SH
DDC	UPDATE TITLE	8-5-16	SH

-1 MPS ETHERNET EXTENDER CABLE (RJ45 FEMALE)

REF	DESCRIPTION	ITEM NO.
V	156062-70 CABLE ASSEMBLY	5
V	O.S. 9/10" FIT 221 1/4" DIA. HEAT SHRINK, BLACK	4
V	O.S. 4471 LOCTITE	3
1	BIN AE-313 CAT 5E SHIELDED NETWORK EXTENSION CABLE	2
1	STK 156063-1 CONNECTOR SHELL REWORK	1

LOCATOR	PART NUMBER	DESCRIPTION	ITEM NO.
-1		Scanivalve LIBERTY LAKE, WA	
DRAWN	DATE	NAME	
7-11-16	SH		
CHECKED	7-11-16	CJH	
ENGINEER	7-11-16	CJH	
MODEL REV: A		TITLE: MPS ETHERNET EXTENDER CABLE (RJ45 FEMALE)	
ASSEMBLY DRAWING	SIZE	DWG. NO.	REV
	A	156110	-
CAD: SOLIDWORKS 2016		SCALE: N/A	ERO#: A-982
SHEET 1 OF 1			

MPSTCU BREAKOUT CABLE

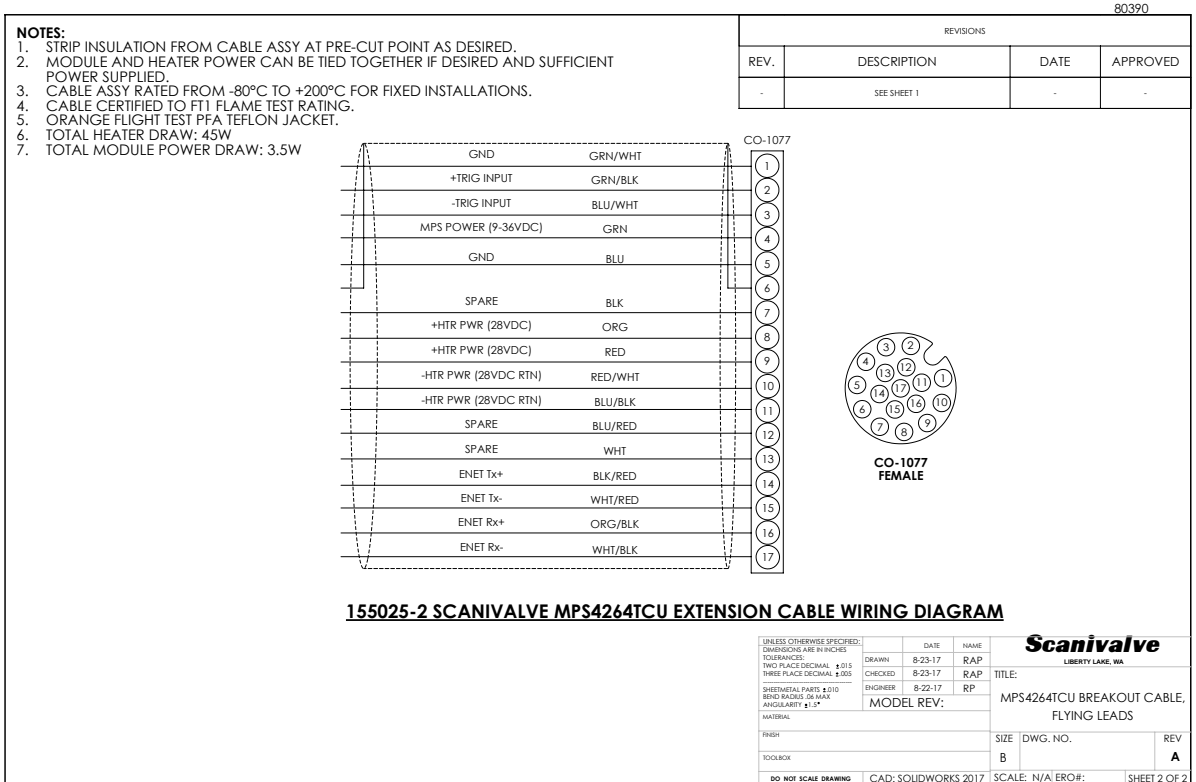
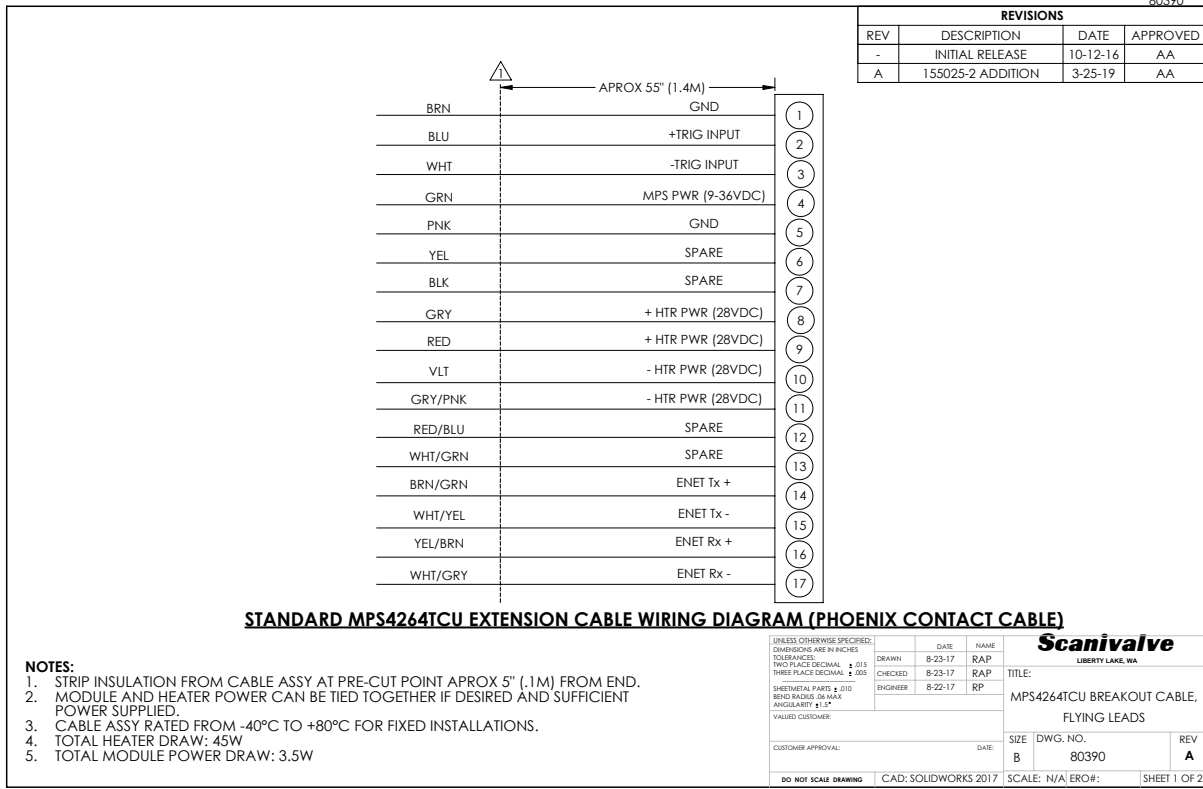

APPENDIX G - SOFTWARE REVISION LOG

- Version 1.00 - Never released
- Version 2.00 - Initial release (8/24/2016)
- Version 2.01 - Improved temperature mapping of sensors. Improved reliability of calibration via SPC4000. (2/9/17)
- Version 2.02 - Added median filtering to calibration. Added auto multi-unit validation for users with an SPC4000. (2/24/17)
- Version 2.03 - Resolved a bug that didn't allow the current temperature plane to be read before a CALZ. (3/6/17)
- Version 2.04 - Added automatic and manual field validation capabilities for single and multiple units. Allowed a Telnet connection to be established while in the webserver. (4/28/2017)
- Version 2.05 - Added support for multiple calibration ovens. Added the ability for an MPS to act as a PTP Master. Resolved an issue with the scan rate and time with the binary packet over the binary server. Resolved a bug that altered the temperature averaging of the Binary LabVIEW packet. Resolved a bug that caused errors when scanning multiple units via FTP. (11/9/2017)
- Version 2.06 - Removed SAVE C and SAVE T from the SAVE command. Resolved an issue with SET FORMAT. Added new error routing. Added DINT and EINT around clock update. Added integral to servo control loop. Resolved PTP reset issue. (9/5/2018)
- Version 2.07 - Improved reliability of FTP data collection at high scan rates. (1/11/19)
- Version 2.08 - Fixed a timing issue when external frame triggering. Improved web server GUI and features. Added Electric Valve support. Improved scan rate reliability with added data output buffer. Corrected an issue with the CALVAL command. Changed the temperature mapping scheme. Removed 4 frame binary data buffer that was added in 2.07. Added CALVER command. Added Telnet time-out configuration options. Added optional Output Rate value under SET RATE. Multiple minor bug fixes. Upgrading to this version requires a factory calibration. (8/30/19)
- Version 2.09 - Resolved a race condition when using Scan triggering. Webserver can now be accessed using IP Address only. Minor adjustment with CALZ routine. Fixed an issue that occurred when Tar.ndx file was missing. (10/28/19)
- Version 2.10 - Resolved an issue with CALZ when performing a multi-unit validation. (11/6/19)
- Version 2.11 - Added DREQ variable in order to adjust the rate of Delay_Req packets sent by MPS when using PTP. Changed PTP Transport Flag to 0x0. Modified scan rate setting to optimize PTP synchronization between MPS modules. Resolved an issue with dual FTP/UDP output. Resolved an issue when using external scan trigger and binary server. Resolved an issue using SETTIME command when setting hours between 19 and 23. (3/23/21)
-
- Version 3.00 - *Based on Version 2.10* - EU conversion modified from points interpolation to a polynomial model, least squares fit. Implementation of internal Field Cal/Val. Modified CALAVG to accept rate and average for CAL and VAL independently. Modified CAL/VAL routines for simultaneous calibrator reads, configurable "special" dwells, and remote scan reporting. Modified EU conversion to output 999999 error when nominal pressure range x 1.1 is exceeded. Disabled commands MXMN and CTP. Modified file system to accept "Cal_<sn>.cfg" as the default coefficient file. A SAVE C will create the Cal_<sn>.cfg file using the SN variable. (12/11/20)
- Version 3.01 - Added DREQ variable and ETOL variable to LIST M. Changed PTP Transport Flag to 0x0. Modified scan rate setting to optimize PTP synchronization between MPS modules. Resolved an issue with dual FTP/UDP output. Resolved an issue when using external scan trigger and binary server. Resolved an issue using SETTIME command when setting hours between 19 and 23. Allow VALVESTATE command to be sent during SCAN. Minor bug fixes when using an Electric Valve. (4/29/21)
- Version 3.02 - Improved the accuracy of the XTIME (external trigger) time stamps. Improved the calibration routine success rate. Correct a CALZ issue when SSD/SST were set to a time in the future. (11/17/21)
- Version 3.03 - Correct an issue when setting UTCOFFSET to a negative value less than 1 hour. Corrected a bug that would cause Autostart to only send a few frames of data before stopping. Prevented the Webserver from being accessed when Autostart is enabled. Allows SIM to be set to 64 with no changes (MPS4232 compatibility). Fixed the LOAD and TYPE commands when no argument was provided. (10/5/2022)
- Version 3.04 - Support manual field calibration and validations. Range checking for SVRSEL variable. Support internal calibration table conversion. Changed "Scan Type" in binary packet to "Serial Number." Fixed bug with CALVER being set on remote devices. Resolved an issue with automated calibrator reads. Fixed issue when TO is used. Minor webserver and bug fixes. (12/6/2022)
- Version 3.05 - Remove requirement to save/power cycle when MCAST is altered. Fixed intermittent scan drift issue. Minor calibration/validation process fixes. Updating to this version requires factory (recommended) or field calibration. (2/1/2024)

[INTENTIONALLY LEFT BLANK]

Scanivalve

**1722 N. MADSON ST.
LIBERTY LAKE, WA 99019**

**PHONE: 1-800-935-5151
1-509-891-9970
FAX: 1-509-891-9481**

**SCANCO@SCANIVALVE.COM
WWW.SCANIVALVE.COM**

**MPS4264 HARDWARE & SOFTWARE MANUAL
FEBRUARY 1, 2024**